

ACTION

KRAFTSTECKSCHLÜSSEL SPINDELGEFÜHRTE STECKSCHLÜSSEL ZUBEHÖR



ACTION

ACTION

INHALT

	KRAFTSTECKSCHLÜSSEL
1/4"	KRAFTSTECKSCHLÜSSEL FÜR DREHSCHRAUBER 6-KANT & GEWINDEBOHRERHALTER
1/4"	KRAFTSTECKSCHLÜSSEL 6-KANT NORMAL 6-KANT TIEF TORX® SURFACE DRIVE KUGELGELENKSCHLÜSSEL
3/8"	6-KANT NORMAL 6-KANT TIEF 12-KANT NORMAL 6-KANT TIEF SURFACE DRIVE TORX® AUSSEN XZN KUGELGELENKSCHLÜSSEL RIBE PROFIL GEWINDEBOHRERHALTER
1/2"	4-KANT / 8-KANT 6-KANT NORMAL 6-KANT TIEF 12-KANT NORMAL 12-KANT TIEF SURFACE DRIVE TORX® KUGELGELENKSCHLÜSSEL AUSSEN XZN RIBE PROFIL GEWINDEBOHRERHALTER STEBBOLZENSETZER
3/4"	4-KANT 6-KANT NORMAL 6-KANT TIEF STEBBOLZENSETZER 8-KANT 12-KANT NORMAL 12-KANT TIEF TORX®

1"	4-KANT NORMAL 6-KANT NORMAL 6-KANT TIEF 8-KANT NORMAL 12-KANT NORMAL 12-KANT TIEF AUSSEN-6-KANT (INBUS)
1 1/2"	6-KANT NORMAL 6-KANT TIEF AUSSEN-6-KANT (INBUS)
2 1/2"	6-KANT NORMAL
	VERBINDUNGSTEILE VERLÄNGERUNGEN VERLÄNGERUNG WOBBLE KUGELGELENKE VERBINDUNGSTEIL MIT AUSSENVIERKANT VERBINDUNGSTEILE SCHNELLWECHSELHALTER
3/8"	SPINDELGEFÜHRTE KRAFTSTECKSCHLÜSSEL 6-KANT NORMAL 6-KANT LANG 6-KANT TIEF TORX® AUSSEN-6-KANT (INBUS)
1/2"	6-KANT NORMAL 6-KANT LANG 6-KANT TIEF TORX® AUSSEN-6-KANT (INBUS) STEBBOLZENSETZER
3/4"	6-KANT NORMAL AUSSEN-6-KANT (INBUS) TORX® VERLÄNGERUNGEN SCHNELLWECHSELHALTER SPINDELGEFÜHRTE BITHALTER
	SETS KRAFTSTECKSCHLÜSSEL KRAFTSTECKSCHLÜSSELSETS TORSIONSKRAFTSTECKSCHLÜSSEL

VIERKANTANTRIEB

Action Kraftsteckschlüssel sind lieferbar für Vierkanttrieb von 1/4" bis 2 1/2". Die Form des Vierkanttriebs dieser Kraftsteckschlüssel ist in den Ecken nach außen abgerundet, wodurch der Antriebsvierkant des Schlagschraubers ausgezeichnet passt. Das bedeutet, dass das Drehmoment weitestgehend übertragen wird, nicht nur in den Ecken des Kraftsteckschlüssels. Hierdurch leben Ihre Kraftsteckschlüssel und Schlagschrauber länger.

SECHSKANT-KRAFTSTECKSCHLÜSSEL

Die von ACTION hergestellten Sechskantkraftsteckschlüssel haben auch abgerundete Ecken. Die abgerundeten Ecken haben hier das Ziel, den Ecken des Sechskants Platz zu lassen, damit die Kraft auf die Flanken des Schraubenkopfes übertragen wird, was zu einer besseren Leistung führt. Durch den Flankenantrieb auf den Schraubenkopf oder die Mutter wird Verschleiß reduziert. Das gilt auch für die Zwölfkantkraftsteckschlüssel.

SURFACE-DRIVE-STECKSCHLÜSSEL

Surface-Drive-Steckschlüssel sind entwickelt, um nur die Mitte der Flanken der Schraube oder Mutter anzutreiben. Die Surface-Drive-Steckschlüssel werden empfohlen für die Verwendung von Nüssen mit abgenutzten Ecken, aber auch bei Nüssen aus weicherem Material bzw. polierten Nüssen und Schrauben.

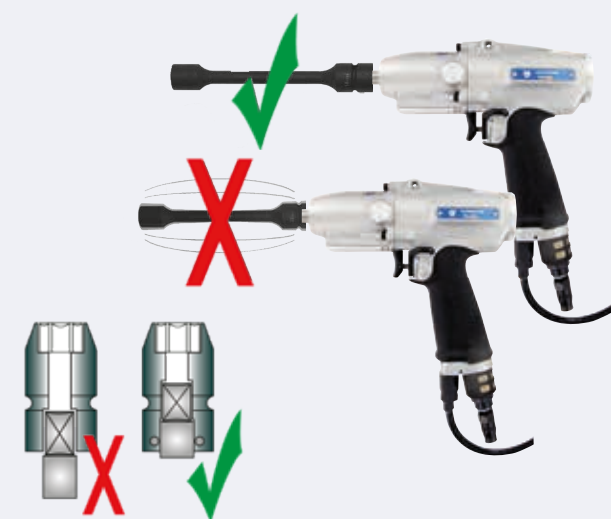
SPINDELGEFÜHRTE KRAFTSTECKSCHLÜSSEL

Steckschlüssel mit Spindelführung wurden auf Wunsch von YOKOTA durch ACTION entwickelt, um die Qualität der Schraubverbindung mit Impulsschraubern zu verbessern. Spindelgeführte Steckschlüssel haben ein minimales Spiel zwischen Steckschlüssel und Antriebsspindel. Dadurch wird das "Wackeln" reduziert und die Drehmomentverluste werden geringer. Der Einsatz von spindelgeführten Steckschlüsseln bietet nicht nur Vorteile für den Schraubfall, sondern vermindert auch den Geräuschpegel und Verschleiß sowie die Vibration der Maschine für den Anwender.

VORSICHT!

Tragen Sie immer eine Sicherheitsbrille bei der Verwendung von Kraftsteckwerkzeug und -geräten. Halten Sie keinen Kraftsteckschlüssel fest, wenn die Maschine in Betrieb ist.

Alle ACTION Kraftsteckschlüssel sind gemäß DIN 3121 und DIN 3129 hergestellt.

Alle Kugelgelenke und dünnwandigen Kraftsteckschlüssel werden ohne Garantie geliefert.

Richtlinie für Maschinen 2006/42/EG und EN/ISO 11148-6 besagt, dass nur Kraftsteckschlüsseinsätze auf Schlagschraubern eingesetzt werden sollen.

➔ Sollten Sie die richtigen Typen oder Abmessungen bzw. Schlüsselweiten in diesem Katalog nicht finden, bitte sprechen Sie uns hierzu an!

1/4" ANTRIEB
6-KANT NORMAL

Typ	mm	Zeichnung	D1 mm	L mm	L1 mm	-
Metrisch						
DO697B0S04	4	A	8	55	4,5	-
DO697B0S06	6	A	10	55	4,5	-
DO697B0S07	7	A	11	55	5	-
DO697B0S08	8	A	12	55	5	-
DO697B0S10	10	A	14	55	6,5	-
DO697B0T06	6	A	10	75	4,5	-
DO697B0T07	7	A	11	75	4,5	-
DO697B0T08	8	A	12	75	4,5	-
DO697B0T10	10	A	14	75	5,5	-
DO697B0T12	12	A	17	75	5,5	-
DO697B0T13	13	A	18	75	5,5	-
DO697B0T14	14	A	19	75	5,5	-
DO697B0W12	12	A	17	200	5,5	-
DO697B0W14	14	A	19	200	5,5	-

6-KANT MAGNETISCH

Typ	mm	Zeichnung	D1 mm	L mm	L1 mm	-
Metrisch						
DO697B0M06	6	B	10	55	4,5	-
DO697B0M07	7	B	11	55	4,5	-
DO697B0M08	8	B	12	55	4,5	-
DO697B0M10	10	B	14	55	5,5	-
DO697B0M11	11	B	16	55	5,5	-
DO697B0M12	12	B	17	55	5,5	-
DO697B0M13	13	B	18	55	5,5	-
DO697B0M14	14	B	19	55	5,5	-
DO697B0N10	10	B	14	75	5,5	-
DO697B0N12	12	B	17	75	5,5	-
DO697B0P06	6	B	10	100	4,5	-
DO697B0P07	7	B	11	100	4,5	-
DO697B0P08	8	B	12	100	4,5	-
DO697B0P10	10	B	14	100	5,5	-
DO697B0P12	12	B	17	100	5,5	-
DO697B0P13	13	B	18	100	5,5	-
DO697B0P14	14	B	19	100	5,5	-
DO697B0P17	17	B	23	100	5,5	-
DO697B0Q10	10	B	14	150	5,5	-
DO697B0R07	7	B	11	200	4,5	-
DO697B0R10	10	B	14	200	5,5	-

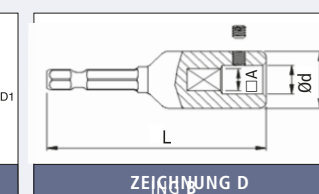
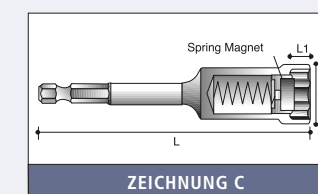
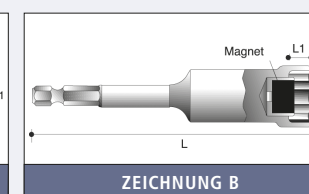
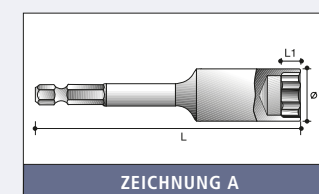
6-KANT TIEF MAGNETISCH

Typ	mm	Zeichnung	D1 mm	L mm	L1 mm	-
Metrisch						
DO697B6006	6	C	10	75	4,5	-
DO697B7006	6	C	10	100	4,5	-
DO697B7008	8	C	12	100	4,5	-
DO697B7010	10	C	14	100	5,5	-
DO697B7012	12	C	17	100	5,5	-
DO697B7013	13	C	18	100	5,5	-
DO697B7014	14	C	19	100	5,5	-
DO697B8006	6	C	10	150	4,5	-
DO697B8008	8	C	12	150	4,5	-
DO697B8010	10	C	14	150	5,5	-
DO697B8012	12	C	17	150	5,5	-
DO697B8013	13	C	18	150	5,5	-
DO697B8014	14	C	19	150	5,5	-
DO697B9006	6	C	10	200	4,5	-
DO697B9008	8	C	12	200	4,5	-
DO697B9010	10	C	14	200	5,5	-
DO697B9012	12	C	17	200	5,5	-
DO697B9013	13	C	18	200	5,5	-
DO697B9014	14	C	19	200	5,5	-

GEWINDEBOHRERHALTER

Typ	A mm	Zeichnung	Ø d mm	Ø D mm	L mm	-
Metrisch						
DO63A65001	3,4	D	4,5	14	55	-
DO63A65002	4,9	D	6	15	55	-
DO63A65003	5,5	D	7	16	55	-
DO63A65004	6,2	D	8	17	60	-
DO63A65005	7	D	9	18	70	-
DO63A65006	8	D	10	19	70	-
DO63A65007	9	D	11	20	70	-
DO63A65008	9	D	12	21	70	-
DO63A65009	11	D	14	23	75	-

KRAFTSTECKSCHLÜSSEL



1/4" ANTRIEB

6-KANT NORMAL 1						
Typ	mm	Zeich-nung	D1 mm	D2 mm	L mm	L2 mm
Metrisch						
DO0014-0-004	4	A	7,6	13	23	4
DO0014-0-0045	4,5	A	8,2	13	23	5
DO0014-0-005	5	A	8,8	13	23	5
DO0014-0-0055	5,5	A	9,5	13	23	5
DO0014-0-006	6	A	10	13	23	6
DO0014-0-007	7	A	11,3	13	23	6
DO0014-0-008	8	A	12,5	13	23	7
DO0014-0-009	9	A	13,8	13	23	7
DO0014-0-010	10	C	15	13	23	7
DO0014-0-011	11	C	16,3	13	23	8
DO0014-0-012	12	C	17	13	23	8
DO0014-0-013	13	C	18,8	13	23	8
DO0014-0-014	14	C	20	13	23	8
DO0014-0-015	15	C	21	13	23	8

6-KANT NORMAL 1						
Typ	mm	Zeich-nung	D1 mm	D2 mm	L mm	L2 mm
Zoll						
DO0014-0-3/16	3/16"	A	8,5	13	23	5
DO0014-0-1/4	1/4"	A	10,3	13	23	6
DO0014-0-5/16	5/16"	A	12,5	13	23	7
DO0014-0-3/8	3/8"	C	15	13	23	7
DO0014-0-7/16	7/16"	C	16,3	13	23	8
DO0014-0-1/2	1/2"	C	18,8	13	23	8

6-KANT TIEF 2						
Typ	mm	Zeich-nung	D1 mm	D2 mm	L mm	L2 mm
Metrisch						
DO0014-1-004	4	A	7,6	13	50	4
DO0014-1-045	4,5	A	8,2	13	50	6
DO0014-1-005	5	A	8,8	13	50	6
DO0014-1-006	6	A	10	13	50	7
DO0014-1-007	7	A	11,3	13	50	7
DO0014-1-008	8	A	12,5	13	50	9
DO0014-1-009	9	C	13,8	13	50	9
DO0014-1-010	10	C	15	13	50	9
DO0014-1-011	11	C	16,3	13	50	9
DO0014-1-012	12	C	17	13	50	9
DO0014-1-013	13	C	18,8	13	50	9
DO0014-1-014	14	C	20	13	50	9
DO0014-1-015	15	C	21	13	50	9

6-KANT NORMAL 3						
Typ	mm	Zeich-nung	D1 mm	D2 mm	L mm	L2 mm
Metrisch						
DO6050P050	5	A	8,8	13	23	3
DO6050P055	5,5	A	9,5	13	23	3
DO6050P060	6	A	10	13	23	3
DO6050P070	7	A	11,3	13	23	3
DO6050P080	8	A	12,5	13	23	3
DO6050P090	9	C	13,8	13	23	4
DO6050P100	10	C	15	13	23	4
DO6050P110	11	C	16,3	13	23	5
DO6050P120	12	C	17	13	23	5
DO6050P130	13	C	18,8	13	23	5
DO6050P140	14	C	20	13	23	6
DO6050P150	15	C	21	13	23	6

6-KANT TIEF MAGNETISCH 4						
Typ	mm	Zeich-nung	D1 mm	D2 mm	L mm	L2 mm
Metrisch						
DO6050R050	5	A	8,8	13	50	3
DO6050R055	5,5	A	9,5	13	50	3
DO6050R060	6	A	10	13	50	3
DO6050R070	7	A	11,3	13	50	3
DO6050R080	8	A	12,5	13	50	3
DO6050R090	9	C	13,8	13	50	4
DO6050R100	10	C	15	13	50	4
DO6050R110	11	C	16,3	13	50	5
DO6050R120	12	C	17	13	50	5
DO6050R130	13	C	18,8	13	50	5
DO6050R140	14	C	20	13	50	6
DO6050R150	15	C	21	13	50	6

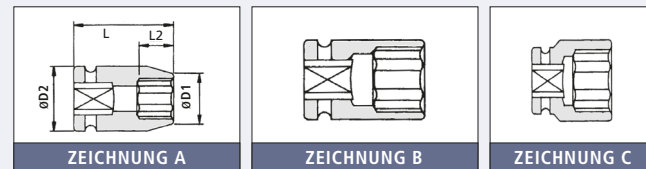

KRAFTSTECKSCHLÜSSEL



1/4" ANTRIEB

AUSSEN-6-KANT (INBUS) 1						
Typ	mm	Zeich-nung	D2 mm	L mm	L1 mm	-
Metrisch						
DO64805025	2,5	D	13	35	4	-
DO64805030	3	D	13	35	6	-
DO64805040	4	D	13	35	6	-
DO64805050	5	D	13	35	6	-
DO64805060	6	D	13	35	8	-
DO64805070	7	D	13	35	8	-
DO64805080	8	D	13	35	8	-
DO64805090	9	D	13	35	10	-
DO64805100	10	D	13	35	10	-

TORX® INTERN 2						
Typ	mm	Zeich-nung	D2 mm	L mm	L1 mm	-
DO64701005	T5	F	13	2	35	-
DO64701006	T6	F	13	2	35	-
DO64701007	T7	F	13	2	35	-
DO64701008	T8	F	13	2	35	-
DO64701009	T9	F	13	2	35	-
DO64701010	T10	F	13	2,8	35	-
DO64701015	T15	F	13	2,8	35	-
DO64701020	T20	F	13	2,8	35	-
DO64701025	T25	F	13	3	35	-
DO64701027	T27	F	13	3	35	-
DO64701030	T30	F	13	3,8	35	-

Torx® ist eine Handelsmarke von Textron.

TORX® TAMPER RESISTANT INTERN 2						
Typ	mm	Zeich-nung	D2 mm	L mm	L1 mm	-
DO64706008	T8	F	13	2,0	35	-
DO64706009	T9	F	13	2,0	35	-
DO64706010	T10	F	13	2,8	35	-
DO64706015	T15	F	13	2,8	35	-
DO64706020	T20	F	13	2,8	35	-
DO64706025	T25	F	13	3,0	35	-
DO64706027	T27	F	13	3,0	35	-
DO64706030	T30	F	13	3,8	35	-

Torx® ist eine Handelsmarke von Textron.

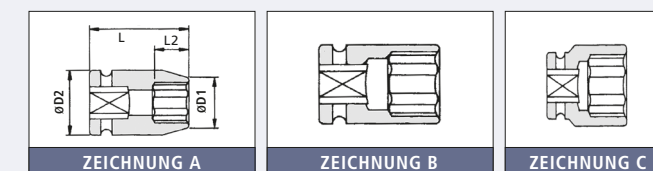

TORX® EXTERN 3						
Typ	mm	Zeich-nung	D1 mm	D2 mm	L mm	L2 mm
DO63300004	E4	A	7,2	13	25	4
DO63300005	E5	A	8	13	25	4,5
DO63300006	E6	A	9	13	25	5
DO63300007	E7	A	9,5	13	25	6
DO63300008	E8	A	10	13	25	6
DO63300010	E10	A	12,5	13	25	7,5
DO63300011	E11	B	13	13	25	8
DO63300012	E12	B	14,5	14,5	25	8,5

Torx® ist eine Handelsmarke von Textron.

TORX® DÜNNWANDIG EXTERN 4						
Typ	mm	Zeich-nung	D1 mm	D2 mm	L mm	L2 mm
DO63305004	E4	A	6,5	13	25	4
DO63305005	E5	A	7,5	13	25	4,5
DO63305006	E6	A	8,5	13	25	5
DO63305007	E7	A	9	13	25	6
DO63305008	E8	A	9,8	13	25	6
DO63305010	E10	A	12	13	25	6,5
DO63305011	E11	A	12,7	13	25	8
DO63305012	E12	A	14	14,5	25	8,5

Dünnwandige Nüsse sind von der ACTION-Garantie ausgeschlossen.
Torx® ist eine Handelsmarke von Textron.

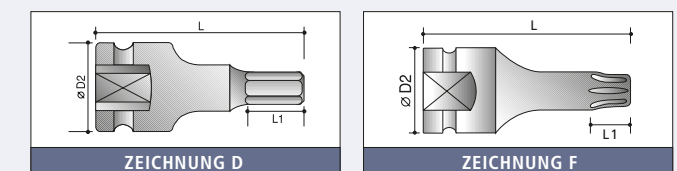

KRAFTSTECKSCHLÜSSEL

1/4" ANTRIEB



SURFACE DRIVE NORMAL 1						
Typ	mm	Zeichnung	D1 mm	D2 mm	L mm	L2 mm
Metrisch						
DO63405040	4	A	7,6	13	23	4
DO63405045	4,5	A	8,2	13	23	5
DO63405050	5	A	8,8	13	23	5
DO63405055	5,5	A	9,5	13	23	5
DO63405060	6	A	10	13	23	6
DO63405070	7	A	11,3	13	23	6
DO63405080	8	A	12,5	13	23	7
DO63405090	9	C	13,8	13	23	7
DO63405100	10	C	15	13	23	7
DO63405110	11	C	16,3	13	23	8
DO63405120	12	C	17	13	23	8
DO63405130	13	C	18,8	13	23	8
DO63405140	14	C	20	13	23	8
DO63405150	15	C	21	13	23	8

SURFACE DRIVE TIEF 2						
Typ	mm	Zeichnung	D1 mm	D2 mm	L mm	L2 mm
Metrisch						
DO63407040	4	A	7,6	13	50	4
DO63407045	4,5	A	8,2	13	50	6
DO63407050	5	A	8,8	13	50	6
DO63407055	5,5	A	9,5	13	50	6
DO63407060	6	A	10	13	50	7
DO63407070	7	A	11,3	13	50	7
DO63407080	8	A	12,5	13	50	9
DO63407090	9	C	13,8	13	50	9
DO63407100	10	C	15	13	50	9
DO63407110	11	C	16,3	13	50	9
DO63407120	12	C	17	13	50	9
DO63407130	13	C	18,8	13	50	9
DO63407140	14	C	20	13	50	9
DO63407150	15	C	21	13	50	9

KUGELGELENKSCHLÜSSEL 6-KANT 3						
Typ	mm	Zeichnung	D1 mm	D2 mm	L mm	L2 mm
Metrisch						
DO62500050	5	E	8,8	15	43	5
DO62500055	5,5	E	9,5	15	43	6
DO62500060	6	E	10	15	43	6
DO62500070	7	E	11,5	15	43	8
DO62500080	8	E	12,5	15	43	8
DO62500090	9	E	14	15	43	8
DO62500100	10	E	15	15	43	8
DO62500110	11	E	16,5	15	43	8
DO62500120	12	E	16,8	16	48	8
DO62500130	13	E	18,8	16	48	8
DO62500140	14	E	19,8	16	48	8
DO62500150	15	E	20,8	16	48	8

Kugelgelenkschlüssel sind von der ACTION-Garantie ausgeschlossen.

RING UND STIFT	
DO1014-0-000	

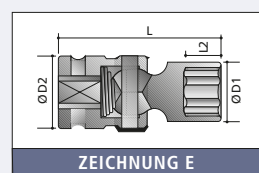
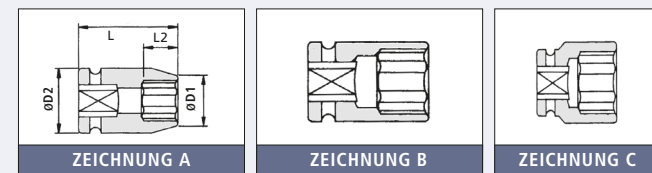

KRAFTSTECKSCHLÜSSEL



3/8" ANTRIEB

6-KANT NORMAL 1						
Typ	mm	Zeichnung	D1 mm	D2 mm	L mm	L2 mm
Metrisch						
DO1038-0-006	6	A	11	19	30	4
DO1038-0-007	7	A	12,5	19	30	8
DO1038-0-008	8	A	14	19	30	8
DO1038-0-009	9	A	15	19	30	8
DO1038-0-010	10	A	16	19	30	8
DO1038-0-011	11	A	17,5	19	30	9
DO1038-0-012	12	B	19	19	30	9
DO1038-0-013	13	A	20	22	30	9
DO1038-0-014	14	A	21	22	30	9
DO1038-0-015	15	B	22	22	30	11
DO1038-0-016	16	C	24	22	30	11
DO1038-0-017	17	C	25	22	30	11
DO1038-0-018	18	C	26	22	30	11
DO1038-0-019	19	C	27,5	22	30	11
DO1038-0-020	20	C	28	22	30	12
DO1038-0-021	21	C	30	22	30	13
DO1038-0-022	22	C	32	23	30	13
DO1038-0-024	24	C	34	23	30	13

6-KANT NORMAL 2						
Typ	mm	Zeichnung	D1 mm	D2 mm	L mm	L2 mm
Zoll						
DO1038-0-5/16	5/16"	A	12,5	19	30	8
DO1038-0-3/8	3/8"	A	14,5	19	30	8
DO1038-0-7/16	7/16"	A	17	19	30	9
DO1038-0-1/2	1/2"	B	19	19	30	9
DO1038-0-9/16	9/16"	B	20	20	30	9
DO1038-0-5/8	5/8"	B	24	24	30	11
DO1038-0-11/16	11/16"	B	24	24	30	11
DO1038-0-3/4	3/4"	B	26	26	30	11
DO1038-0-13/16	13/16"	B	28	28	30	13
DO1038-0-7/8	7/8"	B	30	30	30	13
DO1038-0-15/16	15/16"	B	32	32	30	13

6-KANT NORMAL MAGNETISCH 3						
Typ	mm	Zeichnung	D1 mm	D2 mm	L mm	L2 mm
Metrisch						
DO6051P006	6	A	11,5	19	30	3
DO6051P007	7	A	12,5	19	30	3
DO6051P008	8	A	14	19	30	3
DO6051P009	9	A	15	19	30	4
DO6051P010	10	A	16,5	19	30	4
DO6051P011	11	A	17,5	19	30	5
DO6051P012	12	B	19	19	30	5
DO6051P013	13	A	20	22	30	5
DO6051P014	14	A	21,5	22	30	6
DO6051P015	15	B	22	22	30	6
DO6051P016	16	C	24	22	30	6
DO6051P017	17	C	25	22	30	6
DO6051P018	18	C	26	22	30	7
DO6051P019	19	C	27,5	22	30	7

6-KANT TIEF MAGNETISCH 4						
Typ	mm	Zeichnung	D1 mm	D2 mm	L mm	L2 mm
Metrisch						
DO6051R006	6	A	11,5	19	55	3
DO6051R007	7	A	12,5	19	55	3
DO6051R008	8	A	14	19	55	3
DO6051R009	9	A	15	19	55	4
DO6051R010	10	A	16,5	19	55	4
DO6051R011	11	A	17,5	19	55	5
DO6051R012	12	B	19	19	55	5
DO6051R013	13	A	20	22	55	5
DO6051R014	14	A	21,5	22	55	6
DO6051R015	15	B	22	22	55	6
DO6051R016	16	C	24	22	55	6
DO6051R017	17	C	25	22	55	6
DO6051R018	18	C	26	22	55	7
DO6051R019	19	C	27,5	22	55	7

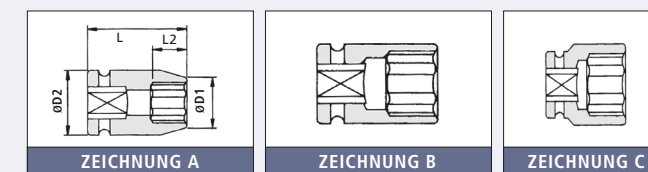

ACTION
KRAFTSTECKSCHLÜSSEL



3/8" ANTRIEB

6-KANT TIEF 1						
Typ	mm	Zeichnung	D1 mm	D2 mm	L mm	L2 mm
Metrisch						
DO1038-1-006	6	A	11	19	63	12
DO1038-1-007	7	A	12,5	19	63	12
DO1038-1-008	8	A	13,8	19	63	12
DO1038-1-009	9	A	15	19	65	12
DO1038-1-010	10	A	16	19	65	12
DO1038-1-011	11	A	17,5	19	65	25
DO1038-1-012	12	B	19	19	65	25
DO1038-1-013	13	A	20	22	65	25
DO1038-1-014	14	A	21	22	65	25
DO1038-1-015	15	B	22	22	65	25
DO1038-1-016	16	C	24	22	65	25
DO1038-1-017	17	C	25	22	65	25
DO1038-1-018	18	C	26	22	65	25
DO1038-1-019	19	C	27,5	22	65	25
DO1038-1-020	20	C	28	22	65	25
DO1038-1-021	21	C	30	22	65	25
DO1038-1-022	22	C	32	23	65	25
DO1038-1-024	24	C	34	23	65	25

12-KANT NORMAL 2						
Typ	mm	Zeichnung	D1 mm	D2 mm	L mm	L2 mm
Metrisch						
DO65815006	6	A	11	19	30	5
DO65815007	7	A	12	19	30	5
DO65815008	8	A	13	19	30	6
DO65815009	9	A	15	19	30	6
DO65815010	10	A	16,5	19	30	7
DO65815011	11	A	17,5	19	30	8
DO65815012	12	A	19	20	30	9
DO65815013	13	A	20	22	30	9
DO65815014	14	A	21,5	22	32	11
DO65815015	15	B	22	22	32	11
DO65815016	16	C	24	22	32	11
DO65815017	17	C	25	22	32	12
DO65815018	18	C	26	22	34	13
DO65815019	19	C	27	22	34	13
DO65815020	20	C	28	22	34	13
DO65815021	21	C	30	22	34	15
DO65815022	22	C	31	23	34	15
DO65815023	23	C	32	23	34	15
DO65815024	24	C	34	23	34	16
DO65815025	25	C	35	23	36	16
DO65815026	26	C	36	23	36	16

12-KANT TIEF 3						
Typ	mm	Zeichnung	D1 mm	D2 mm	L mm	L2 mm
Metrisch						
DO65817006	6	A	11	19	63	5
DO65817007	7	A	12	19	63	5
DO65817008	8	A	13	19	63	6
DO65817009	9	A	15	19	65	6
DO65817010	10	A	16,5	19	65	7
DO65817011	11	A	17,5	19	65	8
DO65817012	12	A	19	20	65	9
DO65817013	13	A	20	22	65	9
DO65817014	14	A	21,5	22	65	11
DO65817015	15	B	22	22	65	11
DO65817016	16	C	24	22	65	11
DO65817017	17	C	25	22	65	11
DO65817018	18	C	26	22	65	13
DO65817019	19	C	27,5	22	65	13
DO65817020	20	C	28	22	65	13
DO65817021	21	C	30	22	65	15
DO65817022	22	C	32	23	65	15
DO65817023	23	C	33	23	65	15
DO65817024	24	C	34	23	65	16
DO65817025	25	C	35	23	65	16
DO65817026	26	C	36	23	65	16

STEBBOLZENSETZER

Typ	Gewinde	D1 mm	D2 mm	L mm
DO69781050	M5x0,8	12	22	50
DO69781053	M6x1,0	12,5	22	50
DO69781056	M7x1,0	13	22	50
DO69781059	M8x1,0	15	22	50
DO69781060	M8x1,25	14,5	22	50
DO69781062	M10x1,25	18	22	50
DO69781063	M10x1,5	17	22	50
DO69781066	M12x1,75	19	22	50

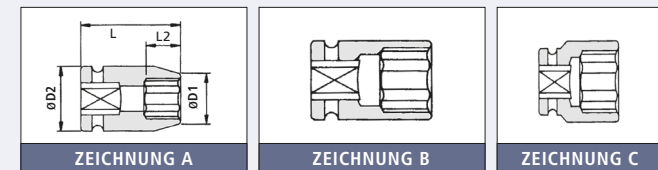
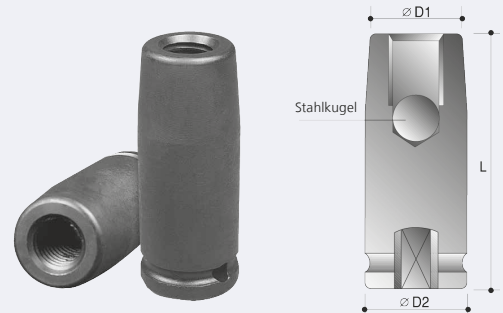

ACTION
KRAFTSTECKSCHLÜSSEL



3/8" ANTRIEB

6-KANT L=150 1						
Typ	mm	Zeichnung	D1 mm	D2 mm	L mm	L2 mm
Metrisch						
DO60715006	6	G	11	19	150	4
DO60715008	8	G	13	19	150	8
DO60715010	10	G	16	19	150	8
DO60715012	12	G	18,5	19	150	9
DO60715013	13	G	20	22	150	9
DO60715014	14	G	21	22	150	9
DO60715015	15	G	22	22	150	11
DO60715016	16	G	24	22	150	11
DO60715017	17	G	25	22	150	11
DO60715018	18	G	26	22	150	12

6-KANT L=200 2						
Typ	mm	Zeichnung	D1 mm	D2 mm	L mm	L2 mm
Metrisch						
DO60716006	6	G	11	19	200	4
DO60716008	8	G	13	19	200	8
DO60716010	10	G	16	19	200	8
DO60716012	12	G	18,5	19	200	9
DO60716013	13	G	20	22	200	9
DO60716014	14	G	21	22	200	9
DO60716015	15	G	22	22	200	11
DO60716016	16	G	24	22	200	11
DO60716017	17	G	25	22	200	11

6-KANT L=250 3						
Typ	mm	Zeichnung	D1 mm	D2 mm	L mm	L2 mm
Metrisch						
DO60717006	6	G	11	19	250	4
DO60717008	8	G	13	19	250	8
DO60717010	10	G	16	19	250	8
DO60717012	12	G	18,5	19	250	9
DO60717013	13	G	20	22	250	9
DO60717014	14	G	21	22	250	9
DO60717015	15	G	22	22	250	11
DO60717016	16	G	24	22	250	11
DO60717017	17	G	25	22	250	11

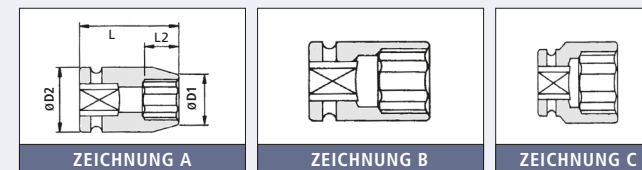

SURFACE DRIVE NORMAL 4						
Typ	mm	Zeichnung	D1 mm	D2 mm	L mm	L2 mm
Metrisch						
DO63415008	8	A	13,8	19	32	8
DO63415009	9	A	15	19	32	8
DO63415010	10	A	16	19	32	8
DO63415011	11	A	17,5	19	32	9
DO63415012	12	B	19	19	32	9
DO63415013	13	A	20	22	32	9
DO63415014	14	B	22	22	32	9
DO63415015	15	B	22	22	32	11
DO63415016	16	C	24	22	32	11
DO63415017	17	C	25	22	32	11
DO63415018	18	C	26	22	32	11
DO63415019	19	C	28	22	32	11

SURFACE DRIVE NORMAL 4						
Typ	Zeichnung	D1 mm	D2 mm	L mm	L2 mm	
Zoll						
DO63410008	1/4"	A	11,5	19	32	4
DO63410010	5/16"	A	13,8	19	32	8
DO63410012	3/8"	A	15,5	19	32	8
DO63410014	7/16"	A	17,5	19	32	9
DO63410016	1/2"	A	20	22	32	9
DO63410018	9/16"	B	22	22	32	11
DO63410020	5/8"	C	24	22	32	11
DO63410022	11/16"	C	26	22	32	11
DO63410024	3/4"	C	28	22	32	11

TORX® INTERN 5						
Typ	Teke-nung	D2 mm	L1 mm	L mm	-	
DO64711009	T9	F	19	2,8	50	-
DO64711010	T10	F	19	2,8	50	-
DO64711015	T15	F	19	2,8	50	-
DO64711020	T20	F	19	3,0	50	-
DO64711025	T25	F	19	3,0	50	-
DO64711027	T27	F	19	3,8	50	-
DO64711030	T30	F	19	3,8	50	-
DO64711040	T40	F	19	4,3	50	-
DO64711045	T45	F	19	5,0	50	-
DO64711047	T47	F	19	5,0	50	-
DO64711050	T50	F	19	5,5	50	-

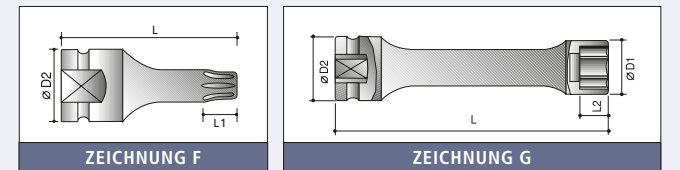

KRAFTSTECKSCHLÜSSEL



3/8" ANTRIEB

SURFACE DRIVE TIEF 1						
Typ	mm	Zeich-nung	D1 mm	D2 mm	L mm	L2 mm
Metrisch						
DO63417008	8	A	13,8	19	80	12
DO63417009	9	A	15	19	80	12
DO63417010	10	A	16	19	80	12
DO63417011	11	A	17,5	19	80	25
DO63417012	12	B	19	19	80	25
DO63417013	13	A	20	22	80	25
DO63417014	14	B	22	22	80	25
DO63417015	15	B	22	22	80	25
DO63417016	16	C	24	22	80	25
DO63417017	17	C	25	22	80	25
DO63417018	18	C	26	22	80	25
DO63417019	19	C	28	22	80	25

SURFACE DRIVE TIEF 1						
Typ	Zeich-nung	D1 mm	D2 mm	L mm	L2 mm	
Zoll						
DO63412010	5/16"	A	13,8	19	80	12
DO63412012	3/8"	A	15,5	19	80	12
DO63412014	7/16"	A	17,5	19	80	25
DO63412016	1/2"	A	20	22	80	25
DO63412018	9/16"	B	22	22	80	25
DO63412020	5/8"	C	24	22	80	25
DO63412022	11/16"	C	26	22	80	25
DO63412024	3/4"	C	28	22	80	25

TORX® TAMPER RESISTANT INTERN 2						
Typ	Zeich-nung	D2 mm	L1 mm	L mm		-
DO64716020	T20	F	19	3,0	50	-
DO64716025	T25	F	19	3,0	50	-
DO64716027	T27	F	19	3,8	50	-
DO64716030	T30	F	19	3,8	50	-
DO64716040	T40	F	19	4,3	50	-
DO64716045	T45	F	19	5,0	50	-
DO64716047	T47	F	19	5,0	50	-
DO64716050	T50	F	19	5,5	50	-
DO64716055	T55	F	19	5,5	50	-

Torx® ist eine Handelsmarke von Textron.

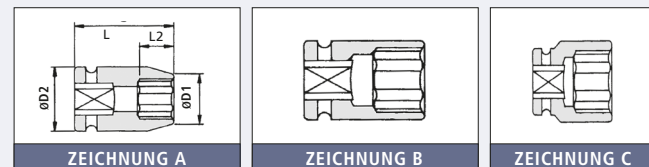

TORX® EXTERN 3						
Typ	Zeich-nung	D1 mm	D2 mm	L mm	L2 mm	
DO63310005	E5	A	9	19	32	4,5
DO63310006	E6	A	10	19	32	5
DO63310007	E7	A	10	19	32	6
DO63310008	E8	A	10,5	19	32	6
DO63310010	E10	A	12,5	19	32	7,5
DO63310011	E11	A	14,5	19	32	8
DO63310012	E12	A	15	19	32	8,5
DO63310014	E14	A	17,5	19	32	10
DO63310016	E16	B	19	19	32	11
DO63310018	E18	B	21	21	34	12,5

Torx® ist eine Handelsmarke von Textron.

TORX® EXTERN MAGNETISCH 4						
Typ	Zeich-nung	D1 mm	D2 mm	L mm	L2 mm	
Metrisch						
DO6331N008	E8	A	11,5	19	32	5
DO6331N010	E10	A	13,5	19	32	5
DO6331N011	E11	A	14	19	32	5
DO6331N012	E11	A	15,5	19	32	6
DO6332N014	E14	A	17,5	19	32	8
DO6332N016	E16	A	19	19	32	9
DO6332N018	E18	A	21	21	32	9

Torx® ist eine Handelsmarke von Textron.

TORX® DÜNNWANDIG EXTERN 4						
Typ	Zeich-nung	D1 mm	D2 mm	L mm	L2 mm	
DO63315005	E5	A	8	19	32	4,5
DO63315006	E6	A	9	19	32	5
DO63315007	E7	A	9,3	19	32	6
DO63315008	E8	A	10	19	32	6
DO63315010	E10	A	12,3	19	32	7,5
DO63315011	E11	A	13	19	32	8
DO63315012	E12	A	14	19	32	8,5
DO63315014	E14	A	16,5	19	32	10
DO63315016	E16	A	18,4	19	32	11

Dünnwandige Kraftsteckchlüssel sind von der ACTION-Garantie ausgeschlossen. Torx® ist eine Handelsmarke von Textron.

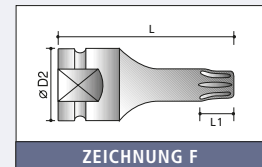

KRAFTSTECKSCHLÜSSEL



3/8" ANTRIEB

6-KANT DÜNNWANDIG NORMAL 1						
Typ	mm	Zeich-nung	D1 mm	D2 mm	L mm	L2 mm
Metrisch						
DO61110006	6	A	10,5	19	30	4
DO61110007	7	A	11,5	19	30	8
DO61110008	8	A	12,5	19	30	8
DO61110009	9	A	14	19	30	8
DO61110010	10	A	15	19	30	8
DO61110011	11	A	17	19	30	9
DO61110012	12	A	17,5	19	30	9
DO61110013	13	B	19	19	30	9
DO61110014	14	B	20	20	30	9

Dünnwandige Kraftsteckschlüssel sind von der ACTION-Garantie ausgeschlossen.

6-KANT DÜNNWANDIG TIEF 2						
Typ	mm	Zeich-nung	D1 mm	D2 mm	L mm	L2 mm
Metrisch						
DO61112007	7	A	11,5	19	65	12
DO61112008	8	A	12,5	19	65	12
DO61112009	9	A	14	19	65	12
DO61112010	10	A	15	19	65	25
DO61112011	11	A	17	19	65	25
DO61112012	12	A	17,5	19	65	25
DO61112013	13	B	19	19	65	25
DO61112014	14	B	20	20	65	25
DO61112015	15	A	21	22	65	25
DO61112016	16	C	22,5	22	65	25
DO61112017	17	C	24	22	65	25
DO61112018	18	C	25	22	65	25
DO61112019	19	C	26	22	65	25
DO61112020	20	C	27	22	65	25
DO61112021	21	C	28	22	65	25
DO61112022	22	C	30	23	65	25

Dünnwandige Kraftsteckschlüssel sind von der ACTION-Garantie ausgeschlossen.

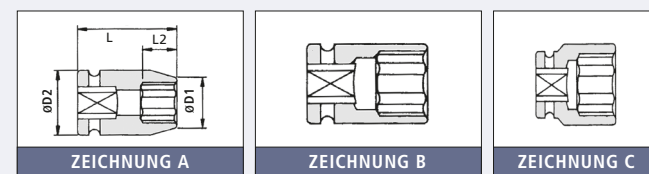

6-KANT KUGELGELENKSCHLÜSSEL NORMAL 3						
Typ	mm	Zeich-nung	D1 mm	D2 mm	L mm	L2 mm
Metrisch						
DO1038-2-009	9	E	15	24	53	9
DO1038-2-010	10	E	15	24	53	9
DO1038-2-011	11	E	17	24	53	9
DO1038-2-012	12	E	19	24	53	12
DO1038-2-013	13	E	19	24	53	13
DO1038-2-014	14	E	21	24	53	13
DO1038-2-015	15	E	22	24	53	13
DO1038-2-016	16	E	23	24	53	13
DO1038-2-017	17	E	25	24	53	13
DO1038-2-018	18	E	25	24	53	13
DO1038-2-019	19	E	27	24	53	13
DO1038-2-020	20	E	30	24	53	13
DO1038-2-021	21	E	30	24	53	13
DO1038-2-022	22	E	32	24	53	13

6-KANT KUGELGELENKSCHLÜSSEL TIEF 4						
Typ	mm	Zeich-nung	D1 mm	D2 mm	L mm	L2 mm
Metrisch						
DO1038-4-009	9	E	15	24	78	20
DO1038-4-010	10	E	15	24	78	20
DO1038-4-011	11	E	17	24	80	20
DO1038-4-012	12	E	19	24	80	20
DO1038-4-013	13	E	19	24	80	20
DO1038-4-014	14	E	21	24	80	20
DO1038-4-015	15	E	22	24	80	20
DO1038-4-016	16	E	23	24	80	20
DO1038-4-017	17	E	25	24	80	20
DO1038-4-018	18	E	25	24	80	20
DO1038-4-019	19	E	27	24	80	25
DO1038-4-020	20	E	30	24	80	25
DO1038-4-021	21	E	30	24	80	25
DO1038-4-022	22	E	32	24	80	25

Kugelgelenkschlüssel sind von der ACTION-Garantie ausgeschlossen.

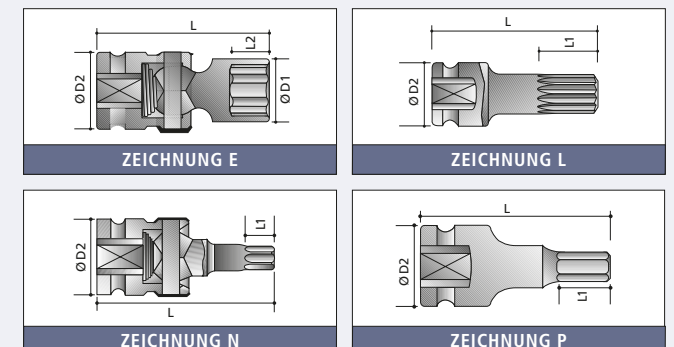

KRAFTSTECKSCHL.



3/8" ANTRIEB

AUSSEN-6-KANT (INBUS) 1						
Typ	Zeichnung	D2 mm	L mm	L1 mm		
Metrisch						
DO696203A	3	P	19	50	16	-
DO696204A	4	P	19	50	16	-
DO696205A	5	P	19	50	16	-
DO696206A	6	P	19	50	16	-
DO696207A	7	P	19	50	16	-
DO696208A	8	P	19	50	16	-
DO696209A	9	P	19	50	16	-
DO696210A	10	P	19	50	16	-
DO696211A	11	P	19	50	16	-
DO696212A	12	P	19	50	16	-
DO696213A	13	P	19	50	16	-
DO696214A	14	P	19	50	16	-
DO696215A	15	P	19	50	16	-
DO696216A	16	P	19	50	16	-

AUSSEN XZN 2						
Typ	Zeichnung	D2 mm	L mm	L1 mm		
Metrisch						
DO65216005	M5	L	19	50	7	-
DO65216006	M6	L	19	50	7	-
DO65216008	M8	L	19	50	9	-
DO65216010	M10	L	19	50	9	-
DO65216012	M12	L	19	50	11	-
DO65216014	M14	L	19	50	11	-
DO65216016	M16	L	19	50	13	-

AUSSEN XZN LANG 3						
Typ	Zeichnung	D2 mm	L mm	L1 mm		
Metrisch						
DO65217005	M5	L	19	100	7	-
DO65217006	M6	L	19	100	7	-
DO65217008	M8	L	19	100	9	-
DO65217010	M10	L	19	100	9	-
DO65217012	M12	L	19	100	11	-
DO65217014	M14	L	19	100	11	-
DO65217016	M16	L	19	100	13	-
DO65218005	M5	L	19	120	7	-
DO65218006	M6	L	19	120	7	-
DO65218008	M8	L	19	120	9	-
DO65218010	M10	L	19	120	9	-
DO65218012	M12	L	19	120	11	-
DO65218014	M14	L	19	120	11	-
DO65218016	M14	L	19	120	13	-

AUSSEN-6-KANT (INBUS) 4						
Typ	Zeichnung	D2 mm	L mm	L2 mm		
Metrisch						
DO65110005	5	N	24	60	11	-
DO65110006	6	N	24	60	11	-
DO65110007	7	N	24	60	15	-
DO65110008	8	N	24	60	15	-
DO65110009	9	N	24	60	15	-
DO65110010	10	N	24	60	15	-
DO65110011	11	N	24	60	15	-
DO65110012	12	N	24	60	15	-
DO65110013	13	N	24	60	15	-
DO65110014	14	N	24	60	15	-
DO65110015	15	N	24	60	15	-
DO65110016	16	N	24	60	15	-

Kugelgelenkschlüssel sind von der ACTION-Garantie ausgeschlossen.

KUGELGELENKSCHLÜSSEL FÜR INTERN TORX® 5						
Typ	Zeichnung	D2 mm	L mm			
DO64910020	T20	N	24	60	-	-
DO64910025	T25	N	24	60	-	-
DO64910027	T27	N	24	60	-	-
DO64910030	T30	N	24	60	-	-
DO64910040	T40	N	24	60	-	-
DO64910045	T45	N	24	60	-	-
DO64910047	T47	N	24	60	-	-
DO64910050	T50	N	24	60	-	-
DO64910055	T55	N	24	60	-	-

Kugelgelenkschlüssel sind von der ACTION-Garantie ausgeschlossen.

KUGELGELENKSCHLÜSSEL FÜR EXTERN TORX® 6						
Typ	Zeichnung	D2 mm	L mm	L2 mm		
DO68710005	E5	E	24	50	4,5	-
DO68710006	E6	E	24	50	5	-
DO68710007	E7	E	24	50	6	-
DO68710008	E8	E	24	50	6	-
DO68710010	E10	E	24	50	7,5	-
DO68710012	E12	E	24	50	8,5	-
DO68710014	E14	E	24	50	10	-
DO68710016	E16	E	24	50	11	-

Kugelgelenkschlüssel sind von der ACTION-Garantie ausgeschlossen.

RING UND STIFT	
DO1038-0-000	



KRAFTSTECKSCHLÜSSEL



3/8" ANTRIEB

RIBE PROFIL 1						
Typ	Zeichnung	D2 mm	L mm	L1 mm		
Metrisch						
DO65315005	M5	H	19	50	4,5	-
DO65315006	M6	H	19	50	5	-
DO65315007	M7	H	19	50	6,5	-
DO65315008	M8	H	19	50	7,5	-
DO65315010	M10	H	19	50	9	-
DO65315012	M12	H	19	50	10	-
DO65315014	M14	H	19	50	12	-
DO65315016	M16	H	19	50	14	-

GEWINDEBOHRHALTER 2						
Typ	A mm	Zeichnung	Ø D1 mm	Ø D2 mm	Ø d mm	L mm
Metrisch						
DO6321B001	3,4	J	19	19	4,5	38
DO6321B002	4,9	J	19	19	6,0	38
DO6321B003	5,5	J	19	19	7,0	40
DO6321B004	6,2	J	19	19	8,0	40
DO6321B005	7,0	J	19	19	9,0	43
DO6321B006	8,0	J	19	19	10,0	45
DO6321B007	9,0	J	19	19	11,0	45
DO6321B008	9,0	J	22	22	12,0	45
DO6321B009	11,0	J	22	22	14,0	45

1/2" ANTRIEB

4-KANT NORMAL 3						
Typ	Zeichnung	D1 mm	D2 mm	L mm	L2 mm	
Metrisch						
DO63125007	7	A	17,5	25	40	8
DO63125008	8	A	19	25	40	9
DO63125010	10	A	21,5	25	40	10
DO63125011	11	A	23	25	40	11
DO63125012	12	A	24	25	40	12
DO63125013	13	A	26	30	40	12
DO63125014	14	A	27,5	30	40	20
DO63125016	16	B	30	30	40	20
DO63125017	17	C	32	30	40	20
DO63125019	19	C	36	30	45	20
DO63125021	21	C	40	30	45	20
DO63125022	22	C	42	30	45	20
DO63125024	24	C	44	30	50	22
DO63125030	30	C	53	30	50	22
DO63125032	32	C	56	30	50	22

8-KANT 4						
Typ	Zeichnung	D1 mm	D2 mm	L mm	L2 mm	
Metrisch						
DO2012-8-010	10	A	20	22	38	7
DO2012-8-014	14	B	26	26	38	11
DO2012-8-017	17	B	30	30	38	11
DO2012-8-019	19	B	34	34	40	13
DO2012-8-022	22	B	38	38	40	15
DO2012-8-024	24	B	42	38	45	18
DO2012-8-027	27	B	46,5	46,5	50	19
DO2012-8-028	28	B	49	49	50	19

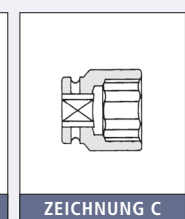
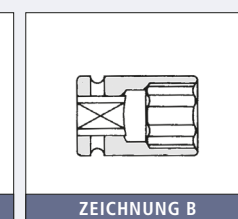
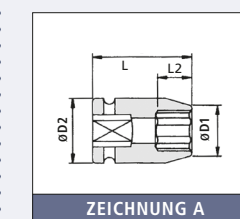
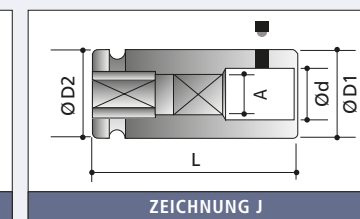
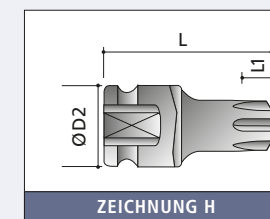

ACTION
KRAFTSTECKSCHLÜSSEL



ACTION
KRAFTSTECKSCHLÜSSEL



□ 1/2" ANTRIEB

6-KANT NORMAL 1

Typ	Zeichnung	D1 mm	D2 mm	L mm	L2 mm
Metrisch					
DO2012-0-008	8 A	14,5	25	38	9
DO2012-0-009	9 A	16	25	38	12
DO2012-0-010	10 A	17	25	38	12
DO2012-0-011	11 A	19	25	38	12
DO2012-0-012	12 A	20	24	38	12
DO2012-0-013	13 A	21	25	38	12
DO2012-0-014	14 A	22	25	38	12
DO2012-0-015	15 A	24	30	38	12
DO2012-0-016	16 A	25	30	38	12
DO2012-0-017	17 A	26	30	38	13
DO2012-0-018	18 A	27,5	30	38	13
DO2012-0-019	19 A	29	30	38	13
DO2012-0-020	20 B	30	30	38	13
DO2012-0-021	21 B	32	30	38	13
DO2012-0-022	22 C	32	30	38	13
DO2012-0-023	23 C	32,5	30	38	13
DO2012-0-024	24 C	35	30	45	20
DO2012-0-025	25 C	36	30	45	20
DO2012-0-026	26 C	37,5	30	45	22
DO2012-0-027	27 C	39	30	50	22
DO2012-0-028	28 C	40	30	50	22
DO2012-0-029	29 C	41	30	50	22
DO2012-0-030	30 C	42,5	30	50	22
DO2012-0-032	32 C	44	30	50	28
DO2012-0-034	34 C	45	30	50	28
DO2012-0-036	36 C	48	30	50	28
DO2012-0-038	38 C	53	38	50	24
DO2012-0-041	41 C	58	44	60	27
DO2012-0-046	46 C	65	44	70	30
DO2012-0-050	50 C	70	52	70	32

6-KANT NORMAL 1

Typ	Zeichnung	D1 mm	D2 mm	L mm	L2 mm
Zoll					
DO2012-0-3/8	3/8"	16	22	38	12
DO2012-0-7/16	7/16"	18	22	38	12
DO2012-0-1/2	1/2"	20	22	38	12
DO2012-0-9/16	9/16"	22	24	38	12
DO2012-0-5/8	5/8"	25	25	38	12
DO2012-0-11/16	11/16"	26	26	38	13
DO2012-0-3/4	3/4"	28	28	38	13
DO2012-0-13/16	13/16"	30	30	38	13
DO2012-0-7/8	7/8"	32	32	38	13
DO2012-0-15/16	15/16"	34	34	38	13
DO2012-0-1	1"	36	36	38	14
DO2012-0-1 1/16	1 1/16"	38	38	40	16
DO2012-0-1 1/8	1 1/8"	40	38	40	16
DO2012-0-1 3/16	1 3/16"	42	38	40	16
DO2012-0-1 1/4	1 1/4"	44	38	40	18
DO2012-0-1 3/8	1 3/8"	48,5	38	50	26
DO2012-0-1 7/16	1 7/16"	50,5	38	50	26
DO2012-0-1 1/2	1 1/2"	52,5	38	50	26

6-KANT NORMAL MAGNETISCH 2

Typ	Zeichnung	D1 mm	D2 mm	L mm	L2 mm
Metrisch					
DO6052P008	8 A	15	25	38	3
DO6052P009	9 A	16	25	38	4
DO6052P010	10 A	17,5	25	38	4
DO6052P011	11 A	18,5	25	38	5
DO6052P012	12 A	20	25	38	5
DO6052P013	13 A	21	25	38	5
DO6052P014	14 A	22,5	25	38	6
DO6052P015	15 A	23,7	30	38	6
DO6052P016	16 A	25	30	38	6
DO6052P017	17 A	26,5	30	38	6
DO6052P018	18 A	27,5	30	38	7
DO6052P019	19 A	29	30	38	7
DO6052P020	20 B	30	30	38	7
DO6052P021	21 C	31	30	38	8
DO6052P022	22 C	32,5	30	38	8
DO6052P024	24 C	35	30	45	10

6-KANT TIEF 3

Typ	Zeichnung	D1 mm	D2 mm	L mm	L2 mm
Metrisch					
DO2012-1-008	8 A	14,5	25	78	13
DO2012-1-009	9 A	16	25	78	14
DO2012-1-010	10 A	17	25	78	14
DO2012-1-011	11 A	18	25	78	14
DO2012-1-012	12 A	19,5	25	78	14
DO2012-1-013	13 A	21	25	78	14
DO2012-1-014	14 A	22	25	78	17
DO2012-1-015	15 A	23,5	30	78	17
DO2012-1-016	16 A	23,5	30	78	17
DO2012-1-017	17 A	26	30	78	17
DO2012-1-018	18 A	26	30	78	17
DO2012-1-019	19 A	28	30	78	19
DO2012-1-020	20 B	30,5	30	78	19
DO2012-1-021	21 B	31	30	78	24
DO2012-1-022	22 C	32,5	30	78	24
DO2012-1-023	23 C	32,5	30	78	24
DO2012-1-024	24 C	35	30	78	24
DO2012-1-025	25 C	36	30	78	24
DO2012-1-026	26 C	37,5	30	78	24
DO2012-1-027	27 C	38	30	78	24
DO2012-1-028	28 C	40	30	78	24
DO2012-1-029	29 C	40	30	78	24
DO2012-1-030	30 C	42	30	78	24
DO2012-1-031	31 C	43	30	78	24
DO2012-1-032	32 C	45	30	78	24
DO2012-1-033	33 C	45	30	90	24
DO2012-1-034	34 C	45	30	90	24
DO2012-1-035	35 C	47	30	90	24
DO2012-1-036	36 C	49	30	90	24
DO2012-1-041	41 C	48	44	93	58
DO2012-1-046	46 C	65	44	93	58



1/2" ANTRIEB

6-KANT TIEF 1						
Typ	Zeichnung	D1 mm	D2 mm	L mm	L2 mm	
Zoll						
DO2012-1-3/8	7/16"	A	16	22	78	14
DO2012-1-7/16	7/16"	A	18	22	78	14
DO2012-1-1/2	1/2"	A	20	22	78	14
DO2012-1-9/16	9/16"	A	22	24	78	17
DO2012-1-5/8	5/8"	B	26	26	78	17
DO2012-1-11/16	11/16"	B	26	26	78	17
DO2012-1-3/4	3/4"	B	28	28	78	19
DO2012-1-13/16	13/16"	B	30	30	78	24
DO2012-1-7/8	7/8"	B	32	32	78	24
DO2012-1-15/16	15/16"	B	28	28	78	19
DO2012-1-1	1"	B	36	36	78	24
DO2012-1-1 1/16	1-1/16"	B	38	38	78	24
DO2012-1-1 1/8	1-1/8"	C	38	38	78	24
DO2012-1-1 3/16	1-3/16"	C	42	38	78	24
DO2012-1-1 1/4	1-1/4"	C	44	38	78	24
DO2012-1-1 5/16	1-5/16"	C	45	38	78	24
DO2012-1-1 3/8	1-3/8"	C	48,5	38	78	24
DO2012-1-1 7/16	1-7/16"	C	50,5	38	78	24
DO2012-1-1 1/2	1-1/2"	C	52,5	38	78	24

6-KANT TIEF MAGNETISCH 2						
Typ	Zeichnung	D1 mm	D2 mm	L mm	L2 mm	
Metrisch						
DO6052R008	8	A	15	25	78	3
DO6052R009	9	A	16	25	78	4
DO6052R010	10	A	17,5	25	78	4
DO6052R011	11	A	18,5	25	78	5
DO6052R012	12	A	20	25	78	5
DO6052R013	13	A	21	25	78	5
DO6052R014	14	A	22,5	25	78	6
DO6052R015	15	A	23,7	30	78	6
DO6052R016	16	A	25	30	78	6
DO6052R017	17	A	26,5	30	78	6
DO6052R018	18	A	27,5	30	78	7
DO6052R019	19	A	29	30	78	7
DO6052R020	20	B	30	30	78	7
DO6052R021	21	C	31	30	78	8
DO6052R022	22	C	32,5	30	78	8
DO6052R024	24	C	35	30	78	10

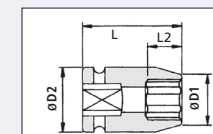

ZEICHNUNG A

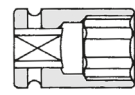

ZEICHNUNG B



ZEICHNUNG C

6-KANT DÜNNWANDIG NORMAL 3						
Typ	Zeichnung	D1 mm	D2 mm	L mm	L2 mm	
Metrisch						
DO61120008	8	A	13	25	38	6
DO61120009	9	A	14,5	25	38	6
DO61120010	10	A	15,5	25	38	7
DO61120011	11	A	16,7	25	38	8
DO61120012	12	A	18	25	38	9
DO61120013	13	A	19,2	25	38	9
DO61120014	14	A	21	25	38	11
DO61120015	15	A	21,7	30	38	11
DO61120016	16	A	23	30	38	11
DO61120017	17	B	24	30	38	11
DO61120018	18	B	25	30	38	13
DO61120019	19	B	26	30	38	13
DO61120020	20	B	27,5	30	38	13
DO61120021	21	B	28	30	38	15
DO61120022	22	B	29,5	30	38	15
DO61120023	23	C	30,5	30	38	15
DO61120024	24	C	32	30	45	18
DO61120030	30	C	40	30	50	21

Dünnwandige Kraftsteckschlüssel sind von der ACTION-Garantie ausgeschlossen.

6-KANT DÜNNWANDIG TIEF 4						
Typ	Zeichnung	D1 mm	D2 mm	L mm	L2 mm	
Metrisch						
DO61122008	8	A	14	22	78	13
DO61122009	9	A	14,5	22	78	14
DO61122010	10	A	15,5	22	78	14
DO61122011	11	A	16,7	22	78	14
DO61122012	12	A	18	22	78	14
DO61122013	13	A	19,2	24	78	14
DO61122014	14	A	21	24	78	17
DO61122015	15	A	21,7	24	78	17
DO61122016	16	A	23	24	78	17
DO61122017	17	B	24	24	78	17
DO61122018	18	B	25	25	78	17
DO61122019	19	B	26	26	78	19
DO61122020	20	B	27,5	27,5	78	19
DO61122021	21	B	28	28	78	24
DO61122022	22	B	29,5	29,5	78	24
DO61122023	23	B	30,5	30,5	78	24
DO61122024	24	B	32	32	78	24
DO61122025	25	B	33	33	78	24
DO61122026	26	B	35	35	78	24
DO61122027	27	B	36	36	78	24
DO61122028	28	B	37,5	37,5	78	24
DO61122030	30	C	40	38	78	24
DO61122031	31	C	41	38	78	24
DO61122032	32	C	42	38	78	24



1/2" ANTRIEB

6-KANT L=150 1						
Typ	Zeichnung	D1 mm	D2 mm	L mm	L2 mm	
Metrisch						
DO60725008	8	G	15	25	150	10
DO60725010	10	G	17,5	25	150	12
DO60725012	12	G	19,5	25	150	12
DO60725013	13	G	21	25	150	12
DO60725014	14	G	22,5	25	150	12
DO60725015	15	G	23,5	30	150	12
DO60725017	17	G	26	30	150	13
DO60725019	19	G	28,5	30	150	13
DO60725020	20	G	30	30	150	13
DO60725021	21	G	31	30	150	13
DO60725022	22	G	32	30	150	14
DO60725024	24	G	34	30	150	14
DO60725025	25	G	36	30	150	15

6-KANT L=200 2						
Typ	Zeichnung	D1 mm	D2 mm	L mm	L2 mm	
Metrisch						
DO60726008	8	G	15	25	200	10
DO60726010	10	G	17,5	25	200	12
DO60726012	12	G	20	25	200	12
DO60726013	13	G	20	25	200	12
DO60726014	14	G	21	25	200	12
DO60726015	15	G	23,5	30	200	12
DO60726017	17	G	26	30	200	13
DO60726019	19	G	28,5	30	200	13
DO60726020	20	G	30	30	200	13
DO60726021	21	G	31	30	200	13

6-KANT L=250 3						
Typ	Zeichnung	D1 mm	D2 mm	L mm	L2 mm	
Metrisch						
DO60727008	8	G	15	25	250	10
DO60727010	10	G	17,5	25	250	12
DO60727012	12	G	20	25	250	12
DO60727013	13	G	20,5	25	250	12
DO60727014	14	G	22,5	25	250	12
DO60727015	15	G	23,5	30	250	12
DO60727017	17	G	26	30	250	13
DO60727019	19	G	28,5	30	250	13
DO60727020	20	G	30	30	250	13
DO60727021	21	G	31	30	250	13
DO60727022	22	G	32	30	250	14

6-KANT DÜNNWANDIG TIEF KUNSTSTOFFBESCHICHTET 4						
Typ	Zeichnung	D1 mm	D2 mm	L mm	L2 mm	
Metrisch						
DO61126015 (weiß)	15	H	22	30	85	13
DO61126017 (blau)	17	H	27	30	85	14
DO61126019 (gelb)	19	H	29	30	85	15
DO61126021 (rot)	21	H	31	30	85	17
DO61126022 (grün)	22	H	32,5	30	85	18

DO6112J017 (blau)	17	H	27	25	130	24
DO6112J019 (gelb)	19	H	29	30	130	24
DO6112J021 (rot)	21	H	31	30	130	24
DO6112J022 (grün)	22	H	32,5	30	130	24

Dünnwandige Kraftsteckschlüssel sind von der ACTION-Garantie ausgeschlossen.

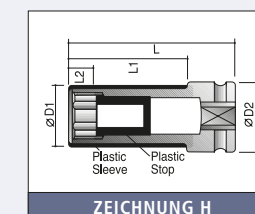

ZEICHNUNG H

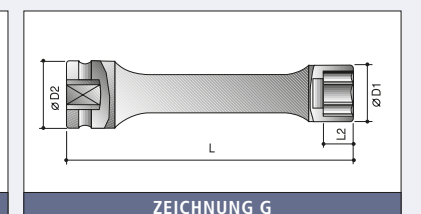

ZEICHNUNG G



□ 1/2" ANTRIEB

12-KANT NORMAL 1						
Typ	Zeichnung	D1 mm	D2 mm	L mm	L2 mm	
Metrisch						
DO63825006	6	A	13	25	38	5
DO63825008	8	A	15	25	38	6
DO63825009	9	A	16	25	38	6
DO63825010	10	A	17,5	25	38	7
DO63825011	11	A	19	25	38	8
DO63825012	12	A	20	25	38	9
DO63825013	13	A	21	25	38	9
DO63825014	14	A	22,5	25	38	11
DO63825015	15	A	23,5	30	38	11
DO63825016	16	A	25	30	38	11
DO63825017	17	A	26,5	30	38	11
DO63825018	18	A	27,5	30	40	13
DO63825019	19	A	29	30	40	13
DO63825020	20	B	30	30	40	13
DO63825021	21	C	31	30	40	15
DO63825022	22	C	32,5	30	40	15
DO63825023	23	C	34	30	40	15
DO63825024	24	C	35	30	45	18
DO63825025	25	C	36	30	45	18
DO63825026	26	C	38	30	50	18
DO63825027	27	C	39	30	50	19
DO63825028	28	C	40	30	50	19
DO63825029	29	C	41	30	50	19
DO63825030	30	C	42,5	30	50	21
DO63825032	32	C	45	30	50	22
DO63825033	33	C	46,5	30	50	22
DO63825036	36	C	50,5	30	50	24
DO63825041	41	C	58,5	44	60	27
DO63825046	46	C	65	44	70	30

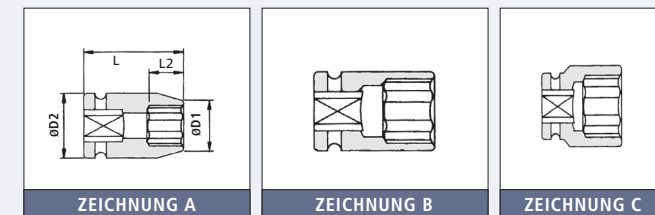

12-KANT TIEF 2						
Typ	Zeichnung	D1 mm	D2 mm	L mm	L2 mm	
Metrisch						
DO65827006	6	A	13	25	83	5
DO65827007	7	A	14	25	83	5
DO65827008	8	A	15	25	83	6
DO65827009	9	A	16	25	83	6
DO65827010	10	A	17,5	25	83	7
DO65827011	11	A	19	25	83	8
DO65827012	12	A	20	25	83	9
DO65827013	13	A	21	25	83	9
DO65827014	14	A	22,5	25	83	11
DO65827015	15	A	23,5	30	83	11
DO65827016	16	A	25	30	83	11
DO65827017	17	A	26,5	30	83	11
DO65827018	18	A	27,5	30	83	13
DO65827019	19	A	29	30	83	13
DO65827020	20	B	30	30	83	13
DO65827021	21	C	31	30	83	15
DO65827022	22	C	32,5	30	90	15
DO65827023	23	C	34	30	90	15
DO65827024	24	C	35	30	90	18
DO65827025	25	C	36	30	90	18
DO65827026	26	C	38	30	90	18
DO65827027	27	C	39	30	90	19
DO65827028	28	C	40	30	90	19
DO65827029	29	C	41	30	90	19
DO65827030	30	C	42,5	30	90	21
DO65827031	31	C	44	30	90	21
DO65827032	32	C	45	30	90	22
DO65827033	33	C	46,5	30	90	22
DO65827034	34	C	48	30	90	22
DO65827035	35	C	49,5	30	90	22
DO65827036	36	C	50,5	30	90	24
DO65827038	38	C	53	38	90	24
DO65827039	39	C	54,5	44	93	24
DO65827040	40	C	56	44	93	58
DO65827041	41	C	58,5	44	93	58
DO65827042	42	C	60	44	93	58
DO65827043	43	C	61	44	93	58
DO65827044	44	C	63	44	93	58
DO65827045	45	C	64	44	93	58
DO65827046	46	C	65	44	93	58
DO65827047	47	C	66,5	44	93	58
DO65827048	48	C	68	44	93	58
DO65827049	49	C	69	44	93	58
DO65827050	50	C	70	52	93	58
DO65827052	52	C	72,5	52	93	58
DO65827054	54	C	75	52	93	58
DO65827056	56	C	77	52	93	58
DO65827057	57	C	78	52	93	58
DO65827058	58	C	79	52	93	58



□ 1/2" ANTRIEB

SURFACE DRIVE NORMAL 1						
Typ	Zeichnung	D1 mm	D2 mm	L mm	L2 mm	
Metrisch						
DO63425010	10	A	17,5	25	38	12
DO63425011	11	A	18,7	25	38	12
DO63425012	12	A	20	25	38	12
DO63425013	13	A	21	25	38	12
DO63425014	14	A	22,5	25	38	12
DO63425015	15	A	23,7	30	38	12
DO63425016	16	A	25	30	38	12
DO63425017	17	A	26	30	38	13
DO63425018	18	A	27,5	30	38	13
DO63425019	19	A	28,7	30	38	13
DO63425020	20	B	30	30	38	13
DO63425021	21	B	30	30	38	13
DO63425022	22	C	32	30	38	13
DO63425023	23	C	32	30	38	13
DO63425024	24	C	35	30	45	20
DO63425026	26	C	38	30	50	22
DO63425027	27	C	38,7	30	50	22
DO63425029	29	C	40	30	50	22
DO63425030	30	C	42	30	50	22
DO63425032	32	C	44	30	50	22

SURFACE DRIVE TIEF 2						
Typ	Zeichnung	D1 mm	D2 mm	L mm	L2 mm	
Metrisch						
DO63427010	10	A	17,5	25	83	14
DO63427011	11	A	18,7	25	83	14
DO63427012	12	A	20	25	83	14
DO63427013	13	A	21	25	83	14
DO63427014	14	A	22,5	25	83	17
DO63427015	15	A	23,7	30	83	17
DO63427016	16	A	25	30	83	17
DO63427017	17	A	26	30	83	17
DO63427018	18	A	27,5	30	83	17
DO63427019	19	A	28,7	30	83	19
DO63427020	20	B	30	30	83	19
DO63427021	21	B	30	30	83	24
DO63427022	22	C	32	30	90	24
DO63427023	23	C	32	30	90	24
DO63427024	24	C	35	30	90	24
DO63427026	26	C	38	30	90	24
DO63427027	27	C	38,7	30	90	24
DO63427029	29	C	40	30	90	24
DO63427030	30	C	42	30	90	24
DO63427032	32	C	44	30	90	24

TORX® INTERN 3						
Typ	Zeichnung	D2 mm	L1 mm	L mm	-	-
DO64721020	T20	F	25	2,8	55	-
DO64721025	T25	F	25	3,0	55	-
DO64721027	T27	F	25	3,0	55	-
DO64721030	T30	F	25	3,8	55	-
DO64721040	T40	F	25	3,8	55	-
DO64721045	T45	F	25	4,3	55	-
DO64721047	T47	F	25	5,0	55	-
DO64721050	T50	F	25	5,0	55	-
DO64721055	T55	F	25	5,5	55	-
DO64721060	T60	F	25	8,0	55	-
DO64721070	T70	F	25	9,4	55	-

Torx® ist eine Handelsmarke von Textron.

TORX® INTERN LANG 4						
Typ	Zeichnung	D2 mm	L1 mm	L mm	-	-
DO64722020	T20	F	25	2,8	75	-
DO64722025	T25	F	25	3,0	75	-
DO64722027	T27	F	25	3,0	75	-
DO64722030	T30	F	25	3,8	75	-
DO64722040	T40	F	25	3,8	75	-
DO64722045	T45	F	25	4,3	75	-
DO64722047	T47	F	25	5,0	75	-
DO64722050	T50	F	25	5,0	75	-
DO64722055	T55	F	25	5,5	75	-
DO64722060	T60	F	25	8,0	75	-
DO64722070	T70	F	25	9,4	75	-
DO64725025	T25	F	25	3,0	150	-
DO64725027	T27	F	25	3,0	150	-
DO64725030	T30	F	25	3,8	150	-
DO64725040	T40	F	25	3,8	150	-
DO64725045	T45	F	25	4,3	150	-

Torx® ist eine Handelsmarke von Textron.

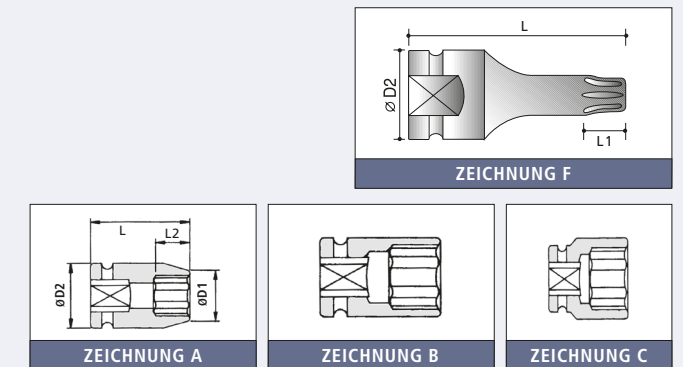

KRAFTSTECKSCHLÜSSEL



1/2" ANTRIEB

★ TORX® TAMPER RESISTANT INTERN 1						
Typ	Zeichnung	D2 mm	L1 mm	L mm	-	
DO64726020	T20	F	25	2,8	55	-
DO64726025	T25	F	25	3,0	55	-
DO64726027	T27	F	25	3,0	55	-
DO64726030	T30	F	25	3,8	55	-
DO64726040	T40	F	25	3,8	55	-
DO64726045	T45	F	25	4,3	55	-
DO64726047	T47	F	25	5,0	55	-
DO64726050	T50	F	25	5,0	55	-
DO64726055	T55	F	25	5,5	55	-
DO64726060	T60	F	25	8,0	55	-
DO64726070	T70	F	25	9,4	55	-

Torx® ist eine Handelsmarke von Textron.

★ TORX® TAMPER RESISTANT INTERN LANG 2						
Typ	Zeichnung	D2 mm	L1 mm	L mm	-	
DO64727020	T20	F	25	2,8	75	-
DO64727025	T25	F	25	3,0	75	-
DO64727027	T27	F	25	3,0	75	-
DO64727030	T30	F	25	3,8	75	-
DO64727040	T40	F	25	3,8	75	-
DO64727045	T45	F	25	4,3	75	-
DO64727047	T47	F	25	5,0	75	-
DO64727050	T50	F	25	5,0	75	-
DO64727055	T55	F	25	5,5	75	-
DO64727060	T60	F	25	8,0	75	-
DO64727070	T70	F	25	9,4	75	-

Torx® ist eine Handelsmarke von Textron.

★ TORX® EXTERN 3						
Typ	Zeichnung	D1 mm	D2 mm	L mm	L2 mm	
DO63320010	E10	A	15	25	38	7,5
DO63320011	E11	A	15,5	25	38	8
DO63320012	E12	A	16	25	38	8,5
DO63320014	E14	A	18,5	25	38	10
DO63320016	E16	A	20	25	38	11
DO63320018	E18	A	22	25	38	12
DO63320020	E20	A	25	30	38	13,5
DO63320022	E22	A	26,5	30	45	18
DO63320024	E24	A	28,5	30	45	18

Torx® ist eine Handelsmarke von Textron.

★ TORX® DÜNNWANDIG EXTERN 4						
Typ	Zeichnung	D1 mm	D2 mm	L mm	L2 mm	
DO63325010	E10	A	13	25	38	7,5
DO63325011	E11	A	14	25	38	8
DO63325012	E12	A	15	25	38	8,5
DO63325014	E14	A	17	25	38	10
DO63325016	E16	A	18,5	25	38	11
DO63325018	E18	A	20,5	25	38	12
DO63325020	E20	A	22,5	30	38	13,5
DO63325022	E22	A	24,5	30	45	18
DO63325024	E24	A	26,5	30	45	18

Dünnwandige Kraftsteckschlüssel sind von der ACTION-Garantie ausgeschlossen.

★ TORX® EXTERN MAGNETISCH 5						
Typ	Zeichnung	D1 mm	D2 mm	L mm	L2 mm	
Metrisch						
DO6332N010	E10	A	14,5	25	38	5
DO6332N011	E11	A	15	25	38	5
DO6332N012	E12	A	16	25	38	6
DO6332N014	E14	A	18	25	38	8
DO6332N016	E16	A	20	25	38	9
DO6332N018	E18	A	22	25	38	9
DO6332N020	E20	A	25	30	38	10
DO6332N022	E22	A	27	30	45	10
DO6332N024	E24	A	29	30	45	11

Torx® ist eine Handelsmarke von Textron.



KRAFTSTECKSCHLÜSSEL



1/2" ANTRIEB

★ 6-KANT KUGELGELENKSCHLÜSSEL NORMAL 1						
Typ	Zeichnung	D1 mm	D2 mm	L mm	L2 mm	
Metrisch						
DO2012-2-010	10	E	15	28	65	14
DO2012-2-011	11	E	17	28	65	14
DO2012-2-012	12	E	19	28	65	14
DO2012-2-013	13	E	20	28	65	14
DO2012-2-014	14	E	22	28	65	14
DO2012-2-015	15	E	23	28	65	14
DO2012-2-016	16	E	23	28	65	14
DO2012-2-017	17	E	26	32	65	14
DO2012-2-018	18	E	26	32	65	14
DO2012-2-019	19	E	28	32	65	14
DO2012-2-020	20	E	30	32	65	14
DO2012-2-021	21	E	30	32	65	14
DO2012-2-022	22	E	32	32	65	14
DO2012-2-023	23	E	32	32	65	14
DO2012-2-024	24	E	34	32	65	14

Kugelgelenkschlüssel sind von der ACTION-Garantie ausgeschlossen.

★ 6-KANT KUGELGELENKSCHLÜSSEL TIEF 2						
Typ	Zeichnung	D1 mm	D2 mm	L mm	L2 mm	
Metrisch						
DO2012-4-010	10	E	15	28	90	14
DO2012-4-011	11	E	17	28	90	20
DO2012-4-012	12	E	19	28	90	20
DO2012-4-013	13	E	20	28	90	20
DO2012-4-014	14	E	22	28	90	20
DO2012-4-015	15	E	23	28	90	20
DO2012-4-016	16	E	23	28	90	20
DO2012-4-017	17	E	26	32	90	20
DO2012-4-018	18	E	26	32	90	20
DO2012-4-019	19	E	28	32	90	25
DO2012-4-020	20	E	30	32	90	25
DO2012-4-021	21	E	30	32	90	25
DO2012-4-022	22	E	32	32	90	25
DO2012-4-023	23	E	32	32	90	25
DO2012-4-024	24	E	34	32	90	25

Kugelgelenkschlüssel sind von der ACTION-Garantie ausgeschlossen.

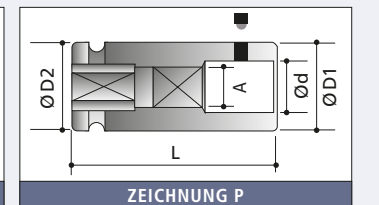
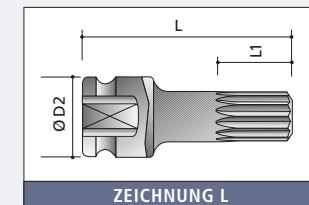
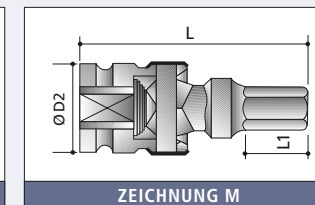
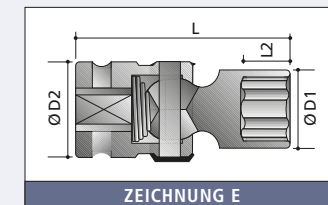

★ KUGELGELENKSCHLÜSSEL FÜR INTERN TORX® 3					
Typ	Zeichnung	D2 mm	L mm	L1 mm	-
DO64921025	T25	M	28	70	3
DO64921027	T27	M	28	70	3
DO64921030	T30	M	28	70	3,8
DO64921040	T40	M	28	70	3,8
DO64921045	T45	M	28	70	4,3
DO64921047	T47	M	28	70	5
DO64921050	T50	M	28	70	5
DO64921055	T55	M	28	70	5,5
DO64921060	T60	M	28	70	8

Kugelgelenkschlüssel sind von der ACTION-Garantie ausgeschlossen.

★ KUGELGELENKSCHLÜSSEL FÜR TORX® EXTERN 4						
Typ	Zeichnung	D1 mm	D2 mm	L mm	L2 mm	
DO68720010	E10	E	13	28	65	7,5
DO68720011	E11	E	14	28	65	8,0
DO68720012	E12	E	15	28	65	8,5
DO68720014	E14	E	17	28	65	10
DO68720016	E16	E	18,5	28	65	11
DO68720018	E18	E	20,5	28	65	12
DO68720020	E20	E	22,5	32	70	13,5
DO68720022	E22	E	24,5	32	70	15
DO68720024	E24	E	26,5	32	70	17

Kugelgelenkschlüssel sind von der ACTION-Garantie ausgeschlossen.



KRAFTSTECKSCHLÜSSEL



1/2" ANTRIEB

AUSSEN-6-KANT (INBUS) 1

Typ	mm	Zeich-nung	D2 mm	L mm	L1 mm	-
Metrisch						
DO696304A	4	K	25	75	11	-
DO696305A	5	K	25	75	15	-
DO696306A	6	K	25	75	15	-
DO696307A	7	K	25	75	15	-
DO696308A	8	K	25	75	16	-
DO696309A	9	K	25	75	16	-
DO696310A	10	K	25	75	16	-
DO696311A	11	K	25	75	16	-
DO696312A	12	K	25	75	16	-
DO696313A	13	K	25	75	16	-
DO696314A	14	K	25	75	16	-
DO696315A	15	K	25	75	16	-
DO696316A	16	K	25	75	16	-
DO696317A	17	K	30	75	16	-
DO696319A	19	K	30	75	16	-
DO696321A	21	K	30	75	16	-
DO696322A	22	K	30	75	16	-
DO696324A	24	K	30	75	16	-
DO64827006	6	K	25	100	15	-
DO64828006	6	K	25	125	15	-
DO64827008	8	K	25	100	16	-
DO64828008	8	K	25	125	16	-
DO64827010	10	K	25	100	16	-
DO64828010	10	K	25	125	16	-
DO64827012	12	K	25	100	16	-
DO64827014	14	K	25	100	16	-

GEWINDEBOHRERHALTER 2

Typ	A mm	Zeich-nung	Ø D1 mm	Ø D2 mm	Ø d mm	L mm
Metrisch						
DO6322B001	3,4	P	22	22	4,5	40
DO6322B002	4,9	P	22	22	6,0	45
DO6322B003	5,5	P	22	22	7,0	45
DO6322B004	6,2	P	22	22	8,0	45
DO6322B005	7,0	P	22	22	9,0	45
DO6322B006	8,0	P	22	22	10,0	45
DO6322B007	9,0	P	22	22	11,0	45
DO6322B008	9,0	P	22	22	12,0	50
DO6322B009	11,0	P	22	22	14,0	52

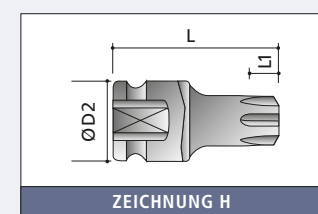
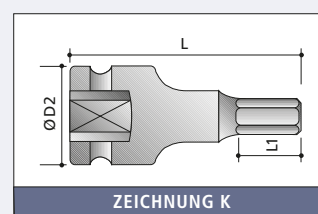

AUSSEN-XZN 3

Typ	mm	Zeich-nung	D2 mm	L mm	L1 mm	-
Metrisch						
DO65226005	M5	L	25	55	7	-
DO65226006	M6	L	25	55	7	-
DO65226008	M8	L	25	55	9	-
DO65226010	M10	L	25	55	9	-
DO65226012	M12	L	25	55	11	-
DO65226014	M14	L	25	55	11	-
DO65226016	M16	L	25	55	13	-

AUSSEN-XZN LANG 4

Typ	mm	Zeich-nung	D2 mm	L mm	L1 mm	-
Metrisch						
DO65227005	M5	L	25	100	7	-
DO65227006	M6	L	25	100	7	-
DO65227008	M8	L	25	100	9	-
DO65227010	M10	L	25	100	9	-
DO65227012	M12	L	25	100	11	-
DO65227014	M14	L	25	100	11	-
DO65227016	M16	L	25	100	13	-
DO65227018	M18	L	25	100	13	-

AUSSEN-XZN EXTRA LANG 4

Typ	mm	Zeich-nung	D2 mm	L mm	L1 mm	-
Metrisch						
DO65228008	M8	L	25	120	9	-
DO65228010	M10	L	25	120	9	-
DO65228012	M12	L	25	120	11	-
DO65228018	M18	L	25	120	14	-

RIBE PROFIL 5

Typ	mm	Zeich-nung	D2 mm	L mm	L1 mm	-
Metrisch						
DO65326006	M6	H	25	55	5	-
DO65326007	M7	H	25	55	6,5	-
DO65326008	M8	H	25	55	7,5	-
DO65326010	M10	H	25	55	9	-
DO65326012	M12	H	25	55	10	-
DO65326014	M14	H	25	55	12	-
DO65326016	M16	H	25	55	14	-
DO65326018	M18	H	25	55	16	-

KRAFTSTECKSCHLÜSSEL



1/2" ANTRIEB

AUSSEN-6-KANT KUGELGELENKSCHLÜSSEL 1

Type	mm	Zeich-nung	D2 mm	L mm	L1 mm	-
Metrisch						
DO65121006	6	M	28	75	13	-
DO65121007	7	M	28	75	13	-
DO65121008	8	M	28	75	20	-
DO65121009	9	M	28	75	20	-
DO65121010	10	M	28	75	20	-
DO65121011	11	M	28	75	20	-
DO65121012	12	M	28	75	20	-
DO65121013	13	M	28	75	20	-
DO65121014	14	M	28	75	20	-
DO65121015	15	M	28	75	20	-
DO65121016	16	M	28	75	20	-
DO65121017	17	M	28	75	20	-
DO65121018	18	M	28	75	20	-
DO65121019	19	M	28	75	20	-

STEBBOLZENSETZER

Typ	Gewinde	D1 mm	D2 mm	L mm
DO69782010	M6 x 1,0	13	25	55
DO69782017	M8 x 1,0	15	25	55
DO69782018	M8 x 1,25	15	25	55
DO69782020	M10 x 1,0	18	25	55
DO69782021	M10 x 1,25	18	25	55
DO69782022	M10 x 1,5	17	25	55
DO69782025	M12 x 1,25	19	25	55
DO69782026	M12 x 1,5	19	25	55
DO69782027	M12 x 1,75	19	25	55
DO69782030	M14 x 1,5	23	25	55
DO69782031	M14 x 2,0	22	25	55
DO69782034	M16 x 1,5	28	30	75
DO69782035	M16 x 2,0	27	30	75
DO69782036	M18 x 1,5	29,5	30	75
DO69782038	M18 x 2,5	29	30	75
DO69782040	M20 x 1,5	30	30	75
DO69782041	M20 x 2,5	30	30	75

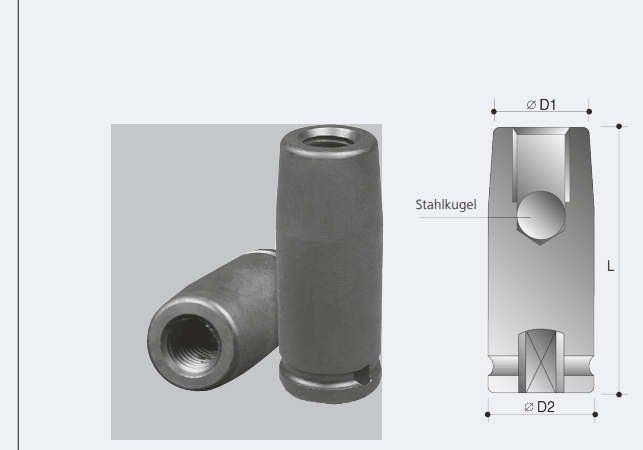

RADMUTTERKRAFTSTECKSCHLÜSSEL 2

Typ	mm	Zeich-nung	D1 mm	D2 mm	L mm	L1 mm
DO69782090	17	R	24	24	38	17
DO69782091	18,5	R	25	25	38	17
DO69782092	20	R	26	26	38	22
DO69782093	21,5	R	28,5	28,5	38	22
DO69782094	23	R	30	30	38	22
DO69782095	24,5	R	31	31	38	22
DO69782096	26	R	32	32	38	22

ANWENDUNG DER RADMUTTERKRAFTSTECKSCHLÜSSEL

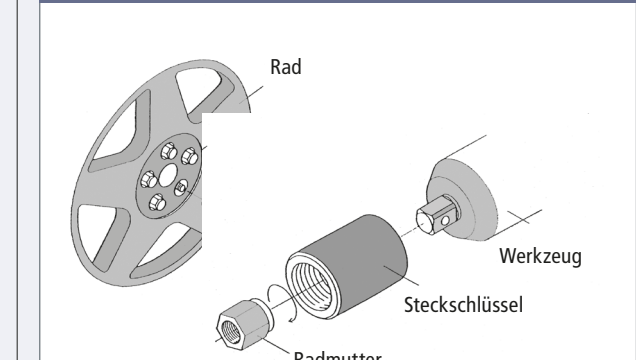

Die Verwendung der Radmutter Schlossentferner ist nur dann erforderlich, wenn der PKW-Fahrer zum Reifendienst geht und den Originalschlüssel vergessen hat. Um doch das Schloss entfernen zu können, werden diese Nüsse verwendet. Beim Aufstecken des Radmutter Schlossentferners beachte man, dass dieser mindestens 3 Gewindegänge tief im Schloss steckt, damit er genug fassen kann.

RING UND STIFT

DO1012-0-000

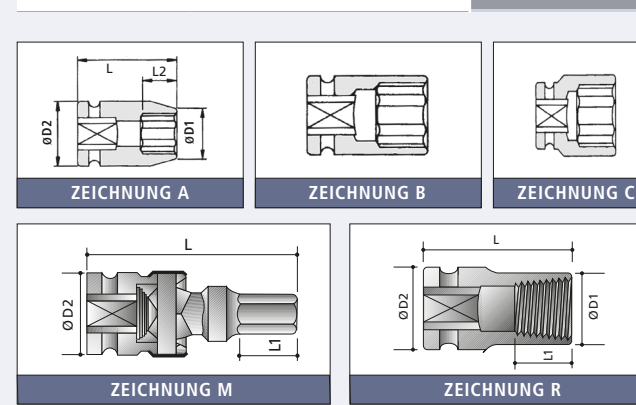

KRAFTSTECKSCHLÜSSEL



3/4" ANTRIEB

4-KANT NORMAL 1

Typ	mm	Zeichnung	D1 mm	D2 mm	L mm	L2 mm
Metrisch						
DO63045016	16	B	40	40	52	24
DO63045017	17	B	40	40	52	24
DO63045019	19	B	40	40	52	24
DO63045020	20	B	42	42	52	24
DO63045021	21	B	42	42	52	24
DO63045022	22	B	44	44	52	24
DO63045024	24	C	47	44	52	24

6-KANT NORMAL 2

Typ	mm	Zeichnung	D1 mm	D2 mm	L mm	L2 mm
Metrisch						
DO3034-0-013	13	A	25	44	50	9
DO3034-0-014	14	A	25	44	50	11
DO3034-0-015	15	A	26	44	50	11
DO3034-0-016	16	A	27	44	50	11
DO3034-0-017	17	A	31	44	50	12
DO3034-0-018	18	A	32	44	50	13
DO3034-0-019	19	A	33	44	50	13
DO3034-0-020	20	A	34	44	50	14
DO3034-0-021	21	A	35	44	50	15
DO3034-0-022	22	A	37	44	50	15
DO3034-0-023	23	A	38	44	50	16
DO3034-0-024	24	A	40	44	50	16
DO3034-0-025	25	A	40	44	50	16
DO3034-0-026	26	A	41	44	50	16
DO3034-0-027	27	A	43	44	54	19
DO3034-0-028	28	B	44	44	54	19
DO3034-0-029	29	C	45	44	54	21
DO3034-0-030	30	C	47	44	54	21
DO3034-0-031	31	C	48	44	56	21
DO3034-0-032	32	C	49	44	56	22
DO3034-0-033	33	C	51	44	56	22
DO3034-0-034	34	C	52	44	56	22
DO3034-0-035	35	C	53	44	56	22
DO3034-0-036	36	C	54	44	56	25
DO3034-0-037	37	C	56	44	58	25
DO3034-0-038	38	C	57	44	58	25
DO3034-0-039	39	C	58	44	58	25
DO3034-0-040	40	C	58	44	58	25
DO3034-0-041	41	C	60	44	58	27
DO3034-0-042	42	C	62	44	58	27
DO3034-0-043	43	C	63	44	63	27
DO3034-0-044	44	C	65	44	63	27
DO3034-0-045	45	C	66	44	63	27
DO3034-0-046	46	C	67	44	63	30
DO3034-0-047	47	C	68	44	68	30
DO3034-0-049	49	C	70	44	70	30
DO3034-0-050	50	C	71	54	72	32
DO3034-0-055	55	C	77	54	74	35

6-KANT NORMAL (FORTSETZUNG) 2

Typ	mm	Zeichnung	D1 mm	D2 mm	L mm	L2 mm
Metrisch						
DO3034-0-056	56	C	80	54	74	35
DO3034-0-057	57	C	84	54	74	35
DO3034-0-060	60	C	84	54	75	37
DO3034-0-063	63	C	86	54	75	37
DO3034-0-065	65	C	88	54	78	40
DO3034-0-067	67	C	90	54	80	40
DO3034-0-070	70	C	96	54	80	40
DO3034-0-075	75	C	102	64	83	42

6-KANT NORMAL 3

Typ	mm	Zeichnung	D1 mm	D2 mm	L mm	L2 mm
Zoll						
DO3034-0-11/16	11/16"	A	29	38	50	12
DO3034-0-3/4	3/4"	A	30	38	50	14
DO3034-0-13/16	13/16"	A	32	38	52	16
DO3034-0-7/8	7/8"	A	34	38	52	16
DO3034-0-15/16	15/16"	A	36	38	52	16
DO3034-0-1 1/8	1 1/8"	B	42	42	52	20
DO3034-0-1 3/16	1 3/16"	B	44	44	52	20
DO3034-0-1 1/4	1 1/4"	B	44	44	52	20
DO3034-0-1	1"	C	40	38	52	16
DO3034-0-1 1/16	1 1/16"	C	40	38	52	16
DO3034-0-1 5/16	1 5/16"	C	47	44	56	23
DO3034-0-1 3/8	1 3/8"	C	50	44	56	23
DO3034-0-1 7/16	1 7/16"	C	51	44	56	23
DO3034-0-1 1/2	1 1/2"	C	53	44	56	23
DO3034-0-1 3/4	1 3/4"	C	65	44	62	27
DO3034-0-1 13/16	1 13/16"	C	67	44	56	32

STEBBOLZENSETZER

Typ	Gewinde	D1 mm	D2 mm	L mm
DO69784162	M16 x 2	29	44	100
DO69784203	M20 x 2,5	35	44	100
DO69784241	M24 x 1,5	37	44	100
DO69784244	M24 x 3	37	44	100
DO69784285	M28 x 3,5	42	44	100
DO69784305	M30 x 3,5	43	44	100

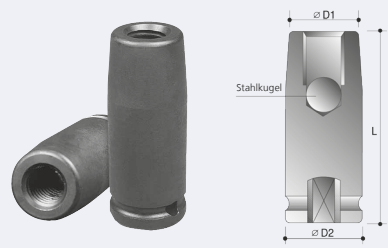

KRAFTSTECKSCHLÜSSEL



3/4" ANTRIEB

6-KANT TIEF 1

Typ	mm	Zeichnung	D1 mm	D2 mm	L mm	L2 mm
Metrisch						
DO3034-1-013	13	A	25	44	95	13
DO3034-1-014	14	A	25	44	95	14
DO3034-1-015	15	A	26	44	95	15
DO3034-1-017	17	A	31	44	95	17
DO3034-1-018	18	A	32	44	95	18
DO3034-1-019	19	A	33	44	95	19
DO3034-1-020	20	A	34	44	95	20
DO3034-1-021	21	A	35	44	95	21
DO3034-1-022	22	A	37	44	95	22
DO3034-1-023	23	A	38	44	95	23
DO3034-1-024	24	A	39,5	44	95	24
DO3034-1-025	25	A	40	44	95	25
DO3034-1-026	26	A	41	44	95	26
DO3034-1-027	27	A	43	44	95	27
DO3034-1-028	28	B	44	44	95	28
DO3034-1-029	29	C	45	44	95	29
DO3034-1-030	30	C	47	44	95	30
DO3034-1-031	31	C	48	44	95	31
DO3034-1-032	32	C	49	44	95	32
DO3034-1-033	33	C	51	44	95	33
DO3034-1-034	34	C	52	44	95	34
DO3034-1-035	35	C	53	44	95	35
DO3034-1-036	36	C	54	44	95	36
DO3034-1-037	37	C	56	44	95	37
DO3034-1-038	38	C	57	44	95	38
DO3034-1-039	39	C	58	44	95	38
DO3034-1-040	40	C	58	44	95	38
DO3034-1-041	41	C	60	44	95	38
DO3034-1-042	42	C	62	44	95	38
DO3034-1-043	43	C	63	44	95	38
DO3034-1-044	44	C	65	44	95	38
DO3034-1-046	46	C	67	44	95	38
DO3034-1-047	47	C	68	44	95	38
DO3034-1-048	48	C	69	44	95	38
DO3034-1-049	49	C	70	44	95	38
DO3034-1-050	50	C	71	54	95	38
DO3034-1-052	52	C	74	54	95	40
DO3034-1-055	55	C	77	54	100	40
DO3034-1-060	60	C	84	54	105	42
DO3034-1-065	65	C	88	54	105	66

6-KANT TIEF 1

Typ	mm	Zeichnung	D1 mm	D2 mm	L mm	L2 mm
Zoll						
DO3034-1-13/16	13/16"	A	32	38	85	23
DO3034-1-7/8	7/8"	A	34	38	85	23
DO3034-1-15/16	15/16"	A	36	38	85	41
DO3034-1-1	1"	C	40	38	85	41
DO3034-1-1 1/8	1 1/8"	B	42	42	85	52
DO3034-1-1 3/16	1 3/16"	B	44	44	85	52
DO3034-1-1 1/4	1 1/4"	B	44	44	85	52
DO3034-1-1 5/16	1 5/16"	C	47	44	85	52
DO3034-1-1 7/16	1 7/16"	C	51	44	85	52
DO3034-1-1 1/2	1 1/2"	C	53	44	85	60

6-KANT EXTRA LANG 2

Typ	mm	Zeichnung	D1 mm	D2 mm	L mm	L2 mm
Metrisch						
DO61145024	24	G	38,5	44	270	24
DO61145027	27	G	42	44	270	27
DO61145030	30	G	45	44	270	30
DO61145032	32	G	47	44	270	32
DO61145033	33	G	48	44	270	32
DO61145036	36	G	53,5	44	270	32
DO61145046	46	G	63	44	270	38
DO61146024	24	G	38,5	44	400	24
DO61146027	27	G	42	44	400	27
DO61146030	30	G	45	44	400	30
DO61146032	32	G	47	44	400	32
DO61146033	33	G	48	44	400	32
DO61146036	36	G	53,5	44	400	32

RING UND STIFT

DO1034-0-000

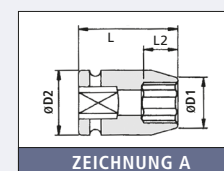

ZEICHNUNG A

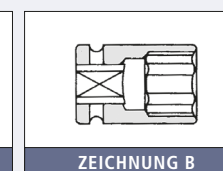

ZEICHNUNG B

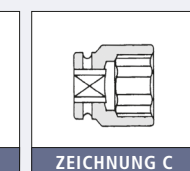

ZEICHNUNG C

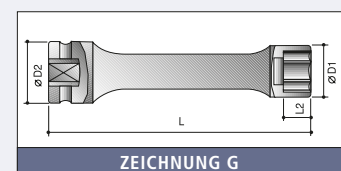

ZEICHNUNG G

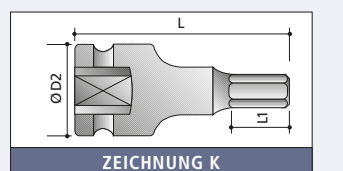

ZEICHNUNG K

KRAFTSTECKSCHLÜSSEL



3/4" ANTRIEB

6-KANT DÜNNWANDIG TIEF 1						
Typ	mm	Zeich-nung	D1 mm	D2 mm	L mm	L2 mm
Metrisch						
DO61141017	17	A	25,5	44	95	17
DO61141019	19	A	28,5	44	95	19
DO61141022	22	A	33,5	44	95	22
DO61141024	24	A	36,5	44	95	24
DO61141027	27	A	40,5	44	95	27
DO61141030	30	A	43,5	44	95	30
DO61141032	32	B	46,5	44	95	32
DO61141033	33	B	47,5	44	95	33
DO61141036	36	B	52	44	95	36
DO61141038	38	B	54	44	95	38
DO61141041	41	B	57	44	95	38

Dünnwandige Kraftsteckschlüssel sind von der ACTION-Garantie ausgeschlossen.

6-KANT EXTREM DÜNNWANDIG TIEF 1						
Typ	mm	Zeich-nung	D1 mm	D2 mm	L mm	L2 mm
Metrisch						
DO61142027	27	A	40	43	108	43
DO61142032	32	B	45	45	108	43
DO61142041	41	C	54,5	45	108	43

Dünnwandige Kraftsteckschlüssel sind von der ACTION-Garantie ausgeschlossen.

AUSSEN 6-KANT (INBUS) 2						
Typ	mm	Zeich-nung	D2 mm	L mm	L1 mm	-
Metrisch						
DO696510A	10	K	44	100	20	-
DO696512A	12	K	44	100	20	-
DO696514A	14	K	44	100	20	-
DO696517A	17	K	44	100	20	-
DO696519A	19	K	44	100	20	-
DO696522A	22	K	44	100	20	-
DO696524A	24	K	44	100	20	-
DO696527A	27	K	44	100	20	-
DO696530A	30	K	44	100	20	-
DO696532A	32	K	44	100	20	-
DO696536A	36	K	44	100	20	-

8-KANT 3						
Typ	mm	Zeich-nung	D1 mm	D2 mm	L mm	L2 mm
Metrisch						
DO63645019	19	B	41	41	52	15
DO63645024	24	C	46	44,5	52	20
DO63645027	27	C	53	44,5	56	24
DO63645030	30	C	60	44,5	60	28
DO63645032	32	C	60	44,5	60	28
DO63645038	38	C	70	44,5	64	32

12-KANT NORMAL 4						
Typ	mm	Zeich-nung	D1 mm	D2 mm	L mm	L2 mm
Metrisch						
DO63845013	13	A	24,5	44	50	9
DO63845014	14	A	25,5	44	50	11
DO63845015	15	A	27	44	50	11
DO63845016	16	A	28	44	50	11
DO63845017	17	A	31	44	50	12
DO63845018	18	A	32	44	50	13
DO63845019	19	A	33	44	50	13
DO63845020	20	A	34	44	50	14
DO63845021	21	A	35	44	50	15
DO63845022	22	A	37	44	50	15
DO63845023	23	A	38	44	50	16
DO63845024	24	A	39	44	50	18
DO63845025	25	B	41	44	50	18
DO63845026	26	C	42	44	50	18
DO63845027	27	C	43	44	54	19
DO63845028	28	C	44	44	54	19
DO63845029	29	C	45	44	54	21
DO63845030	30	C	47	44	54	21
DO63845031	31	C	48	44	56	21
DO63845032	32	C	49	44	56	22
DO63845033	33	C	51	44	56	22
DO63845034	34	C	52	44	56	22
DO63845035	35	C	53	44	56	22
DO63845036	36	C	54	44	56	25
DO63845037	37	C	56	44	58	25
DO63845038	38	C	57	44	58	25
DO63845039	39	C	58	44	58	25
DO63845041	41	C	60	44	58	27
DO63845042	42	C	62	44	58	27
DO63845043	43	C	63,5	44	63	27
DO63845046	46	C	67	44	63	30
DO63845050	50	C	71	54	72	32
DO63845055	55	C	77	54	74	35
DO63845056	56	C	78	54	74	35
DO63845060	60	C	84	54	75	37
DO63845063	63	C	87	54	75	37
DO63845065	65	C	90	54	78	40
DO63845067	67	C	92	54	80	40
DO63845070	70	C	96	54	80	40

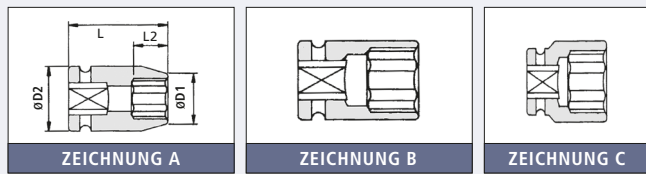

KRAFTSTECKSCHLÜSSEL



3/4" ANTRIEB

12-KANT TIEF 1						
Typ	mm	Zeich-nung	D1 mm	D2 mm	L mm	L2 mm
Metrisch						
DO65847013	13	A	24,5	44	95	13
DO65847014	14	A	25,5	44	95	14
DO65847015	15	A	27	44	95	15
DO65847016	16	A	28	44	95	16
DO65847017	17	A	31	44	95	17
DO65847018	18	A	32	44	95	18
DO65847019	19	A	33	44	95	19
DO65847020	20	A	34	44	95	20
DO65847021	21	A	35	44	95	21
DO65847022	22	A	37	44	95	22
DO65847023	23	A	38	44	95	23
DO65847024	24	A	39	44	95	24
DO65847025	25	A	41	44	95	25
DO65847026	26	A	42	44	95	26
DO65847027	27	A	43	44	95	27
DO65847028	28	B	44	44	95	28
DO65847029	29	C	45	44	95	29
DO65847030	30	C	47	44	95	30
DO65847031	31	C	48	44	95	31
DO65847032	32	C	49	44	95	32
DO65847033	33	C	51	44	95	33
DO65847034	34	C	52	44	95	34
DO65847035	35	C	53	44	95	35
DO65847036	36	C	54	44	95	36
DO65847037	37	C	56	44	95	37
DO65847038	38	C	57	44	95	38
DO65847039	39	C	58	44	95	38
DO65847040	40	C	59	44	95	38
DO65847041	41	C	60	44	95	38
DO65847042	42	C	62	44	95	38
DO65847043	43	C	63,5	44	95	38
DO65847044	44	C	64,5	44	95	38
DO65847045	45	C	65,5	44	95	38
DO65847046	46	C	67	44	100	38
DO65847047	47	C	68	44	100	38
DO65847048	48	C	69	44	100	38
DO65847049	49	C	70	44	100	38
DO65847050	50	C	71	54	100	38
DO65847051	51	C	72	54	100	40
DO65847052	52	C	74	54	100	40
DO65847053	53	C	75	54	100	40
DO65847054	54	C	77	54	100	40
DO65847055	55	C	78	54	105	40
DO65847056	56	C	79	54	105	40
DO65847057	57	C	80	54	105	40
DO65847058	58	C	81	54	105	40

6-KANT TIEF (FORTSETZUNG) 2						
Typ	mm	Zeich-nung	D1 mm	D2 mm	L mm	L2 mm
Metrisch						
DO65847060	60	C	84	54	105	42
DO65847063	63	C	87	54	105	42
DO65847065	65	C	90	54	105	66
DO65847067	67	C	92	54	105	66
DO65847068	68	C	94	54	105	66
DO65847070	70	C	96	54	105	66
DO65847073	73	C	100	54	108	66
DO65847075	75	C	102	64	108	68

TORX® INTERN 3						
Typ	mm	Zeich-nung	D mm	L mm	L1 mm	-
Metrisch						
DO64742050	T50	F	44	100	5,0	-
DO64742055	T55	F	44	100	5,5	-
DO64742060	T60	F	44	100	8,0	-
DO64742070	T70	F	44	100	9,4	-
DO64742080	T80	F	44	100	10,5	-
DO64742090	T90	F	44	100	11,8	-
DO64742100	T100	F	44	100	13,1	-

Torx® ist eine Handelsmarke von Textron.

TORX® EXTERN 4						
Typ	mm	Zeich-nung	D1 mm	D2 mm	L mm	L2 mm
Metrisch						
DO63340018	E18	A	25	44	56	12,5
DO63340020	E20	A	27	44	56	14
DO63340024	E24	A	33	44	56	16,5
DO63340032	E32	A	44	44	56	24,5

Torx® ist eine Handelsmarke von Textron.

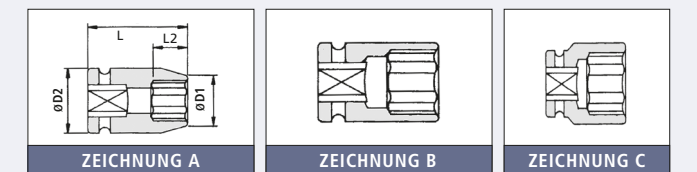

ACTION

KRAFTSTECKSCHLÜSSEL





ACTION

KRAFTSTECKSCHLÜSSEL



1" ANTRIEB

4-KANT NORMAL							1
Typ		Zeichnung	D1 mm	D2 mm	L mm	L2 mm	
Metrisch							
DO63055017	17	B	52	52	57	24	
DO63055019	19	B	52	52	57	24	
DO63055020	20	B	52	52	57	24	
DO63055021	21	B	52	52	57	24	

6-KANT NORMAL							2
Typ		Zeichnung	D1 mm	D2 mm	L mm	L2 mm	
Metrisch							
DO4010-0-017	17	A	34	54	60	12	
DO4010-0-018	18	A	35	54	60	13	
DO4010-0-019	19	A	35,5	54	60	13	
DO4010-0-020	20	A	37	54	60	14	
DO4010-0-021	21	A	38	54	60	15	
DO4010-0-022	22	A	40	54	60	15	
DO4010-0-023	23	A	41	54	60	16	
DO4010-0-024	24	A	42	54	60	18	
DO4010-0-025	25	A	43	54	60	18	
DO4010-0-026	26	A	44,5	54	60	18	
DO4010-0-027	27	A	46	54	60	19	
DO4010-0-028	28	A	47	54	62	19	
DO4010-0-029	29	A	48	54	62	19	
DO4010-0-030	30	A	50	54	62	21	
DO4010-0-031	31	A	51	54	62	21	
DO4010-0-032	32	A	52	54	62	22	
DO4010-0-033	33	A	53	54	62	22	
DO4010-0-034	34	C	55	54	62	22	
DO4010-0-035	35	C	56	54	65	22	
DO4010-0-036	36	C	57	54	67	25	
DO4010-0-037	37	C	59	54	67	25	
DO4010-0-038	38	C	59,5	54	67	25	
DO4010-0-039	39	C	60	54	70	25	
DO4010-0-040	40	C	62	54	70	25	
DO4010-0-041	41	C	64	54	70	27	
DO4010-0-042	42	C	65	54	74	27	
DO4010-0-043	43	C	66	54	74	27	
DO4010-0-045	45	C	68	54	74	27	
DO4010-0-046	46	C	69,5	54	76	30	
DO4010-0-047	47	C	72	54	76	32	
DO4010-0-048	48	C	73	54	76	32	
DO4010-0-050	50	C	74	54	80	35	
DO4010-0-052	52	C	77	54	84	35	
DO4010-0-053	53	C	78	54	84	35	
DO4010-0-054	54	C	79	54	84	35	
DO4010-0-055	55	C	81	54	84	35	

6-KANT NORMAL (FORTSETZUNG)							2
Typ		Zeichnung	D1 mm	D2 mm	L mm	L2 mm	
Metrisch							
DO4010-0-056	56	C	83	54	84	40	
DO4010-0-057	57	C	84	54	84	40	
DO4010-0-058	58	C	85	54	87	40	
DO4010-0-060	60	C	87	54	87	42	
DO4010-0-062	62	C	89	54	87	42	
DO4010-0-063	63	C	90	54	87	42	
DO4010-0-065	65	C	93	54	90	42	
DO4010-0-070	70	C	100	54	96	42	
DO4010-0-075	75	C	106	86	98	45	
DO4010-0-080	80	C	112	86	100	48	
DO4010-0-085	85	C	118	86	105	52	
DO4010-0-090	90	C	125	86	105	52	
DO4010-0-095	95	C	131	86	115	52	
DO4010-0-100	100	C	137	95	115	58	
DO4010-0-105	105	C	143	95	115	58	

6-KANT NORMAL							2
Typ		Zeichnung	D1 mm	D2 mm	L mm	L2 mm	
Zoll							
DO4010-0-1	1"	A	42	51	58	18	
DO4010-0-1 1/8	1 1/8"	A	46	51	58	19	
DO4010-0-1 5/16	1 5/16"	C	53	52	62	21	
DO4010-0-1 7/16	1 7/16"	C	56	52	62	26	
DO4010-0-1 1/2	1 1/2"	C	58	52	62	26	
DO4010-0-1 11/16	1 11/16"	C	65	52	64	27	
DO4010-0-1 7/8	1 7/8"	C	70	58	66	28	
DO4010-0-2 1/16	2 1/16"	C	75	58	70	31	
DO4010-0-2 1/4	2 1/4"	C	84	62	75	34	
DO4010-0-2 7/16	2 7/16"	C	89	62	78	35	
DO4010-0-2 1/2	2 1/2"	C	91	62	80	36	
DO4010-0-2 7/8	2 7/8"	C	102	62	87	41	

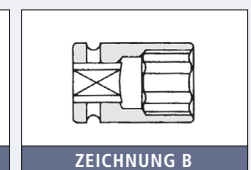
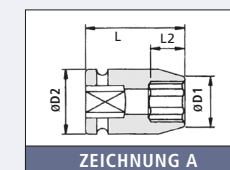

KRAFTSTECKSCHLÜSSEL



1" ANTRIEB

6-KANT TIEF 1

Typ	mm	Zeichnung	D1 mm	D2 mm	L mm	L2 mm
Metrisch						
DO4010-1-017	17	A	34	54	100	17
DO4010-1-018	18	A	34	54	100	18
DO4010-1-019	19	A	35,5	54	100	19
DO4010-1-020	20	A	36,5	54	100	20
DO4010-1-021	21	A	37,5	54	100	21
DO4010-1-022	22	A	40	54	100	22
DO4010-1-023	23	A	41	54	100	23
DO4010-1-024	24	A	42	54	100	24
DO4010-1-025	25	A	43	54	100	25
DO4010-1-026	26	A	44,5	54	100	26
DO4010-1-027	27	A	46	54	100	27
DO4010-1-028	28	A	47	54	100	28
DO4010-1-029	29	A	48	54	100	29
DO4010-1-030	30	A	50	54	100	30
DO4010-1-031	31	A	51	54	100	31
DO4010-1-032	32	A	52	54	100	32
DO4010-1-033	33	A	53	53	100	33
DO4010-1-034	34	C	55	54	100	34
DO4010-1-035	35	C	56	54	100	35
DO4010-1-036	36	C	57	54	100	36
DO4010-1-037	37	C	57	54	100	37
DO4010-1-038	38	C	59,5	54	100	38
DO4010-1-039	39	C	61	54	100	38
DO4010-1-040	40	C	62	54	100	38
DO4010-1-041	41	C	64	54	100	38
DO4010-1-042	42	C	65	54	100	38
DO4010-1-046	46	C	69,5	54	100	38
DO4010-1-047	47	C	71,5	54	100	38
DO4010-1-048	48	C	72,5	54	100	38
DO4010-1-050	50	C	75	54	100	38
DO4010-1-054	54	C	80	54	100	40
DO4010-1-055	55	C	81	54	100	40
DO4010-1-056	56	C	82	54	105	40
DO4010-1-058	58	C	85	54	105	40
DO4010-1-060	60	C	87	54	120	42
DO4010-1-065	65	C	93	54	125	42
DO4010-1-070	70	C	100	54	125	42
DO4010-1-075	75	C	106	86	135	45
DO4010-1-080	80	C	112	86	135	48
DO4010-1-085	85	C	118	86	140	52
DO4010-1-090	90	C	125	86	140	52
DO4010-1-095	95	C	131	86	140	52
DO4010-1-100	100	C	137	95	140	58
DO4010-1-105	105	C	143	95	155	58
DO4010-1-110	110	C	149	95	155	60
DO4010-1-115	115	C	155	95	155	62

6-KANT TIEF 1

Typ	Zeichnung	D1 mm	D2 mm	L mm	L2 mm	
Zoll						
DO4010-1-15/16	15/16"	A	40	51	90	21
DO4010-1-1	1"	A	42	51	90	25
DO4010-1-1 1/16	1 1/16"	A	44	51	90	23
DO4010-1-1 3/16	1 3/16"	A	48	51	90	40
DO4010-1-1 5/16	1 5/16"	C	53	52	90	40
DO4010-1-1 1/2	1 1/2"	C	58	52	92	54

6-KANT DÜNNWANDIGE TIEF 1

Typ	mm	Zeichnung	D1 mm	D2 mm	L mm	L2 mm
Metrisch						
DO61151019	19	A	33	54	100	19
DO61151024	24	A	38	54	100	24
DO61151027	27	A	42,5	54	100	27
DO61151028	28	A	43	54	100	28
DO61151030	30	A	45	54	100	30
DO61151032	32	A	47	54	100	32
DO61151033	33	A	49	54	100	33
DO61151036	36	A	52	54	100	36
DO61151041	41	C	57	54	100	38

6-KANT EXTRA TIEF 2

Typ	mm	Zeichnung	D1 mm	D2 mm	L mm	L2 mm
Metrisch						
DO60559024	24	B	42	54	270	24
DO60559027	27	B	45	54	270	27
DO60559030	30	B	50	54	270	30
DO60559032	32	B	52	54	270	32
DO60559033	33	B	52	54	270	32
DO60559036	36	B	57	54	270	36
DO6115H032	32	B	48,5	54	400	32
DO6115H033	33	B	50	54	400	32

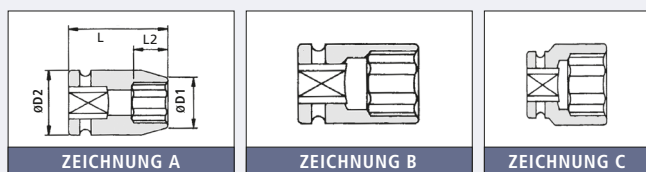

KRAFTSTECKSCHLÜSSEL



1" ANTRIEB

8-KANT NORMAL 1

Typ	mm	Zeichnung	D1 mm	D2 mm	L mm	L2 mm
Metrisch						
DO63655019	19	A	45	54	60	13
DO63655024	24	A	52	54	60	18
DO63655027	27	C	56,5	54	60	19
DO63655030	30	C	61	54	62	21
DO63655032	32	C	64	54	62	22
DO63655035	35	C	68,5	58	65	22
DO63655038	38	C	73	58	67	24
DO63655046	46	C	86	62	76	30

12-KANT NORMAL 2

Typ	mm	Zeichnung	D1 mm	D2 mm	L mm	L2 mm
Metrisch						
DO65855016	16	A	32	54	60	11
DO65855017	17	A	34	54	60	12
DO65855018	18	A	35	54	60	13
DO65855019	19	A	36	54	60	13
DO65855020	20	A	37	54	60	14
DO65855021	21	A	38	54	60	15
DO65855022	22	A	39	54	60	15
DO65855023	23	A	40	54	60	16
DO65855024	24	A	41	54	60	18
DO65855025	25	A	43	54	60	18
DO65855026	26	A	44,5	54	60	18
DO65855027	27	A	45	54	60	19
DO65855028	28	A	46,5	54	62	19
DO65855029	29	A	48	54	62	19
DO65855030	30	A	50	54	62	21
DO65855031	31	A	51	54	62	21
DO65855032	32	A	52	54	62	22
DO65855033	33	A	53	54	62	22
DO65855034	34	C	55	54	62	22
DO65855035	35	C	56	54	65	22
DO65855036	36	C	57	54	67	25
DO65855037	37	C	59	54	67	25
DO65855038	38	C	60	54	67	25
DO65855039	39	C	61	54	70	25
DO65855040	40	C	62	54	70	25
DO65855041	41	C	63,5	54	70	27
DO65855042	42	C	65	54	74	27
DO65855043	43	C	66	54	74	27
DO65855044	44	C	67	54	74	27
DO65855045	45	C	68	54	74	27
DO65855046	46	C	70	58	76	30

12-KANT NORMAL (FORTSETZUNG) 2

Typ	mm	Zeichnung	D1 mm	D2 mm	L mm	L2 mm
Metrisch						
DO65855047	47	C	71,5	58	76	32
DO65855048	48	C	72,5	58	76	32
DO65855050	50	C	75	62	80	35
DO65855051	51	C	76	62	80	35
DO65855052	52	C	77	62	84	35
DO65855053	53	C	78	62	84	35
DO65855054	54	C	80	62	84	35
DO65855055	55	C	81	62	84	35
DO65855056	56	C	82	62	84	40
DO65855057	57	C	84	62	84	40
DO65855058	58	C	85	62	87	40
DO65855060	60	C	87	62	87	42
DO65855062	62	C	89	62	87	42
DO65855063	63	C	90	62	87	42
DO65855065	65	C	93	62	90	42
DO65855067	67	C	96	62	92	42
DO65855070	70	C	100	62	96	42
DO65855075	75	C	106	86	98	45
DO65855076	76	C	107	86	100	48
DO65855077	77	C	109	86	100	48
DO65855078	78	C	110	86	100	48
DO65855080	80	C	112	86	100	80
DO65855085	85	C	118	86	105	52
DO65855090	90	C	125	86	105	52
DO65855095	95	C	131	86	105	52
DO65855100	100	C	137	86	115	58
DO65855105	105	C	143	95	115	58
DO65855110	110	C	149	95	115	60
DO65855115	115	C	155	95	115	62

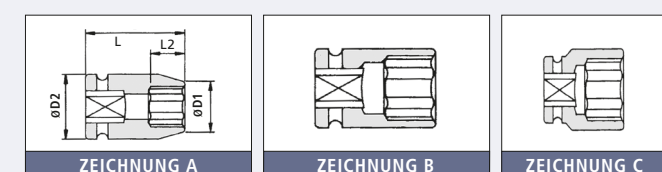

ACTION KRAFTSTECKSCHLÜSSEL



1" ANTRIEB

12-KANT TIEF 1						
Typ	mm	Zeich- nung	D1 mm	D2 mm	L mm	L2 mm
Metrisch						
DO65857016	16	A	32	54	100	16
DO65857017	17	A	34	54	100	17
DO65857018	18	A	35	54	100	18
DO65857019	19	A	36	54	100	19
DO65857020	20	A	37	54	100	20
DO65857021	21	A	38	54	100	21
DO65857022	22	A	40	54	100	22
DO65857023	23	A	41	54	100	23
DO65857024	24	A	42	54	100	24
DO65857025	25	A	43	54	100	25
DO65857026	26	A	44,5	54	100	26
DO65857027	27	A	46	54	100	27
DO65857028	28	A	47	54	100	28
DO65857029	29	A	48	54	100	29
DO65857030	30	A	50	54	100	30
DO65857031	31	A	51	54	100	31
DO65857032	32	A	52	54	100	32
DO65857033	33	A	53	54	100	33
DO65857034	34	C	55	54	100	34
DO65857035	35	C	56	54	100	35
DO65857036	36	C	57	54	100	36
DO65857037	37	C	59	54	100	37
DO65857038	38	C	60	54	100	38
DO65857039	39	C	61	54	100	38
DO65857040	40	C	62	54	100	38
DO65857041	41	C	63	54	100	38
DO65857042	42	C	65	54	100	38
DO65857043	43	C	66	54	100	38
DO65857044	44	C	67	54	100	38
DO65857045	45	C	68	54	100	38
DO65857046	46	C	70	58	100	38
DO65857047	47	C	71,5	58	100	38
DO65857048	48	C	72,5	58	100	38
DO65857050	50	C	75	62	100	38
DO65857051	51	C	76	62	100	40
DO65857052	52	C	77	62	100	40
DO65857053	53	C	78	62	100	40
DO65857054	54	C	80	62	100	40
DO65857055	55	C	81	62	100	40
DO65857056	56	C	82	62	105	40
DO65857057	57	C	84	62	105	40
DO65857058	58	C	85	62	105	40
DO65857060	60	C	87	62	120	42
DO65857062	62	C	89	62	120	42
DO65857063	63	C	90	62	120	42
DO65857065	65	C	93	62	125	42

12-KANT TIEF (FORTSETZUNG) 1						
Typ	mm	Zeich- nung	D1 mm	D2 mm	L mm	L2 mm
Metrisch						
DO65857067	67	C	96	62	125	42
DO65857070	70	C	100	62	125	42
DO65857075	75	C	106	86	135	45
DO65857076	76	C	107	86	135	48
DO65857077	77	C	109	86	135	48
DO65857078	78	C	110	86	135	48
DO65857080	80	C	112	86	135	48
DO65857085	85	C	118	86	140	52
DO65857090	90	C	125	86	140	52
DO65857095	95	C	131	86	140	52
DO65857100	100	C	137	86	140	58
DO65857105	105	C	143	95	155	58
DO65857110	110	C	149	95	155	60
DO65857115	115	C	155	95	155	62

AUSSEN-6-KANT (INBUS) 2						
Typ	mm	Zeich- nung	D2 mm	L mm	L1 mm	-
Metrisch						
DO696610A	10	K	54	100	20	-
DO696612A	12	K	54	100	20	-
DO696614A	14	K	54	100	20	-
DO696617A	17	K	54	100	20	-
DO696619A	19	K	54	100	20	-
DO696622A	22	K	54	100	20	-
DO696622B	22	K	54	140	20	-
DO696624A	24	K	54	100	20	-
DO696627A	27	K	54	100	20	-
DO696630A	30	K	54	100	24	-
DO696632A	32	K	54	100	24	-
DO696636A	36	K	54	100	28	-

RING UND STIFT	
Typ	D2 mm
DO1100-0-000	54
DO1100-0-086	86
DO1100-0-095	95

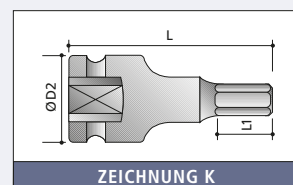

ACTION KRAFTSTECKSCHLÜSSEL



1 1/2" ANTRIEB

6-KANT NORMAL 1						
Typ	mm	Zeich- nung	D1 mm	D2 mm	L mm	L2 mm
Metrisch						
DO5112-0-030	30	A	56	86	78	21
DO5112-0-032	32	A	58	86	78	22
DO5112-0-035	35	A	62	86	78	22
DO5112-0-036	36	A	64	86	78	24
DO5112-0-037	37	A	65	86	78	24
DO5112-0-038	38	A	66	86	78	26
DO5112-0-040	40	A	68	86	78	28
DO5112-0-041	41	A	70	86	80	28
DO5112-0-045	45	A	75	86	84	30
DO5112-0-046	46	A	76	86	84	30
DO5112-0-047	47	A	77	86	84	32
DO5112-0-048	48	A	79	86	84	32
DO5112-0-050	50	A	81	87	87	32
DO5112-0-052	52	A	83	86	87	34
DO5112-0-054	54	B	86	86	90	37
DO5112-0-055	55	B	86	86	90	37
DO5112-0-056	56	B	86	86	92	37
DO5112-0-058	58	C	92	86	92	39
DO5112-0-060	60	C	93	86	92	39
DO5112-0-061	61	C	95	86	95	42
DO5112-0-062	62	C	96	86	95	42
DO5112-0-065	65	C	97	86	95	42
DO5112-0-068	68	C	104	86	100	46
DO5112-0-070	70	C	105	86	100	46
DO5112-0-072	72	C	108	86	108	49
DO5112-0-075	75	C	110	86	108	49
DO5112-0-078	78	C	115	86	115	53
DO5112-0-080	80	C	116	86	115	53
DO5112-0-085	85	C	125	86	118	56
DO5112-0-090	90	C	130	86	123	59
DO5112-0-095	95	C	137	95	123	62
DO5112-0-100	100	C	140	95	130	65
DO5112-0-105	105	C	150	95	130	68
DO5112-0-110	110	C	156	95	135	72
DO5112-0-115	115	C	160	95	140	77
DO5112-0-125	125	C	175	127	140	77

6-KANT TIEF 2						
Typ	mm	Zeich- nung	D1 mm	D2 mm	L mm	L2 mm
Metrisch						
DO5112-1-036	36	A	64	86	115	24
DO5112-1-041	41	A	70	86	115	28
DO5112-1-042	42	A	71	86	115	28
DO5112-1-046	46	A	76	86	115	30
DO5112-1-050	50	A	81	86	135	34
DO5112-1-054	54	B	86	86	140	37
DO5112-1-055	55	B	86	86	140	37
DO5112-1-056	56	B	88	86	140	37
DO5112-1-060	60	C	94	86	150	39
DO5112-1-063	63	C	97	86	150	42
DO5112-1-065	65	C	100	86	150	42
DO5112-1-070	70	C	106	86	160	46
DO5112-1-075	75	C	112	86	170	49
DO5112-1-080	80	C	119	86	170	53
DO5112-1-085	85	C	125	86	170	56
DO5112-1-090	90	C	131	86	170	59
DO5112-1-095	95	C	137	95	180	61
DO5112-1-100	100	C	144	95	190	65
DO5112-1-105	105	C	154	95	190	68
DO5112-1-110	110	C	157	95	200	72
DO5112-1-115	115	C	164	95	210	77
DO5112-1-120	120	C	167	95	210	77
DO5112-1-125	125	C	174	127	210	77

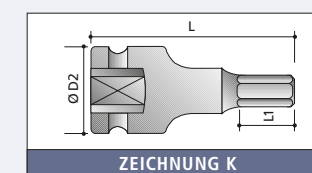
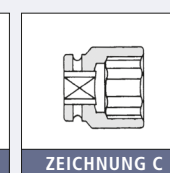
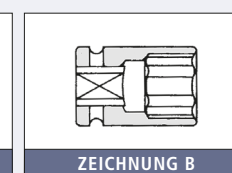
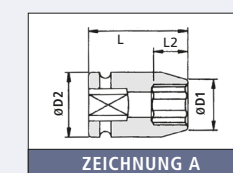

 1 1/2" ANTRIEB

 AUSSEN-6-KANT (INBUS) 1

Typ	mm	Zeichnung	D2mm	L mm	L1 mm	-
Metrisch						
DO64866019	19	K	86	105	20	-
DO64866022	22	K	86	105	20	-
DO64866024	24	K	86	105	20	-
DO64866027	27	K	86	105	20	-
DO64866030	30	K	86	105	20	-
DO64866032	32	K	86	105	20	-
DO64866033	33	K	86	105	20	-
DO64866041	41	K	86	105	20	-
DO64866046	46	K	86	105	20	-
DO64866050	50	K	86	105	20	-
DO64866055	55	K	86	105	20	-

DO64865019	19	K	86	120	20	-
DO64865022	22	K	86	120	20	-
DO64865024	24	K	86	120	20	-
DO64865027	27	K	86	120	20	-
DO64865030	30	K	86	120	24	-
DO64865032	32	K	86	120	24	-
DO64865033	33	K	86	120	24	-
DO64865036	36	K	86	120	28	-
DO64865038	38	K	86	120	28	-
DO64865041	41	K	86	120	34	-
DO64865046	46	K	86	120	38	-
DO64865050	50	K	86	120	38	-
DO64865055	55	K	86	120	43	-

RING UND STIFT

Typ	D2 mm
DO1112-0-000	86
DO1112-0-095	95
DO1112-0-127	127

 2 1/2" ANTRIEB

 6-KANT NORMAL 2

Typ	mm	Zeichnung	D1 mm	D2 mm	L mm	L2 mm
Metrisch						
DO6212-0-060	60	A	99	127	125	37
DO6212-0-065	65	A	105	127	130	40
DO6212-0-070	70	A	110	127	130	40
DO6212-0-075	75	A	118	127	140	42
DO6212-0-077	77	A	122	127	140	45
DO6212-0-080	80	A	124	127	140	45
DO6212-0-085	85	C	130	127	140	52
DO6212-0-090	90	C	136	127	145	52
DO6212-0-095	95	C	143	127	145	52
DO6212-0-100	100	C	149	127	150	58
DO6212-0-105	105	C	155	127	155	58
DO6212-0-110	110	C	161	127	160	60
DO6212-0-115	115	C	167	127	165	62
DO6212-0-120	120	C	176	127	170	67
DO6212-0-125	125	C	184	127	175	72
DO6212-0-130	130	C	188	152	175	72
DO6212-0-135	135	C	195	152	180	77
DO6212-0-140	140	C	204	152	180	77
DO6212-0-145	145	C	207	152	185	83
DO6212-0-150	150	C	214	152	185	83
DO6212-0-155	155	C	224	152	190	90
DO6212-0-160	160	C	227	152	190	90
DO6212-0-165	165	C	234	152	195	95
DO6212-0-170	170	C	244	152	195	95
DO6212-0-175	175	C	247	152	200	100
DO6212-0-180	180	C	254	152	200	100
DO6212-0-185	185	C	257	152	210	105
DO6212-0-190	190	C	265	152	210	105
DO6212-0-200	200	C	275	152	220	110

DO6212-0-105	105	C	155	127	155	58
DO6212-0-110	110	C	161	127	160	60
DO6212-0-115	115	C	167	127	165	62
DO6212-0-120	120	C	176	127	170	67
DO6212-0-125	125	C	184	127	175	72
DO6212-0-130	130	C	188	152	175	72
DO6212-0-135	135	C	195	152	180	77
DO6212-0-140	140	C	204	152	180	77
DO6212-0-145	145	C	207	152	185	83
DO6212-0-150	150	C	214	152	185	83
DO6212-0-155	155	C	224	152	190	90
DO6212-0-160	160	C	227	152	190	90
DO6212-0-165	165	C	234	152	195	95
DO6212-0-170	170	C	244	152	195	95
DO6212-0-175	175	C	247	152	200	100
DO6212-0-180	180	C	254	152	200	100
DO6212-0-185	185	C	257	152	210	105
DO6212-0-190	190	C	265	152	210	105
DO6212-0-200	200	C	275	152	220	110

RING UND STIFT

DO2112-0-000	
--------------	--



VERLÄNGERUNGEN

 VERLÄNGERUNGEN MIT STIFTLOCH 1

Typ	mm	Zeichnung	D mm	L mm
Zoll				
DO7014-0-050	1/4"	B	13	50
DO7014-0-100	1/4"	B	13	100
DO7014-0-150	1/4"	B	13	150
DO7038-0-075	3/8"	B	19	75
DO7038-0-100	3/8"	B	19	100
DO7038-0-125	3/8"	B	19	125
DO7038-0-150	3/8"	B	19	150
DO7038-0-200	3/8"	B	19	200
DO7038-0-250	3/8"	B	19	250
DO7012-0-075	1/2"	B	25	75
DO7012-0-100	1/2"	B	25	100
DO7012-0-125	1/2"	B	25	125
DO7012-0-150	1/2"	B	25	150
DO7012-0-175	1/2"	B	25	175
DO7012-0-200	1/2"	B	25	200
DO7012-0-250	1/2"	B	25	250
DO7012-0-300	1/2"	B	25	300
DO7012-0-460	1/2"	B	25	460
DO7012-0-610	1/2"	B	25	610
DO7012-0-915	1/2"	B	25	915
DO7034-0-075	3/4"	B	44	75
DO7034-0-100	3/4"	B	44	100
DO7034-0-125	3/4"	B	44	125
DO7034-0-150	3/4"	B	44	150
DO7034-0-175	3/4"	B	44	175
DO7034-0-200	3/4"	B	44	200
DO7034-0-250	3/4"	B	44	250
DO7034-0-330	3/4"	B	44	330
DO7034-0-400	3/4"	B	44	400
DO7100-0-075	1"	B	54	75
DO7100-0-100	1"	B	54	100
DO7100-0-125	1"	B	54	125
DO7100-0-150	1"	B	54	150
DO7100-0-175	1"	B	54	175
DO7100-0-200	1"	B	54	200
DO7100-0-250	1"	B	54	250
DO7100-0-300	1"	B	54	300
DO7100-0-330	1"	B	54	330
DO7100-0-350	1"	B	54	350
DO7100-0-400	1"	B	54	400
DO7112-0-125	1 1/2"	B	86	125
DO7112-0-250	1 1/2"	B	86	250
DO7112-0-500	1 1/2"	B	86	500
DO7212-0-250	2 1/2"	B	127	250
DO7212-0-500	2 1/2"	B	127	500

Ring und Stift werden bei den Verlängerungen mit Stiftloch nicht mitgeliefert. Bitte separat bestellen.

 VERLÄNGERUNGEN MIT KUGELSICHERUNG 2

Typ	mm	Zeichnung	D2 mm	L mm
Zoll				
DO6862075	3/8"	A	19	75
DO6862100	3/8"	A	19	100
DO6862125	3/8"	A	19	125
DO6862150	3/8"	A	19	150
DO6862250	3/8"	A	19	250
DO6863075	1/2"	A	25	75
DO6863100	1/2"	A	25	100
DO6863125	1/2"	A	25	125
DO6863250	1/2"	A	25	250

 VERLÄNGERUNGEN MIT SICHERUNGSTIFT 3

Typ	mm	Zeichnung	D2 mm	L mm
Zoll				
DO64514075	3/8"	A	19	75
DO64514100	3/8"	A	19	100
DO64514125	3/8"	A	19	125
DO64514150	3/8"	A	19	150
DO64514200	3/8"	A	19	200
DO64514250	3/8"	A	19	250
DO64524075	1/2"	A	25	75
DO64524100	1/2"	A	25	100
DO64524125	1/2"	A	25	125
DO64524150	1/2"	A	25	150
DO64524200	1/2"	A	25	200
DO64524250	1/2"	A	25	250
DO64524460	1/2"	A	25	460

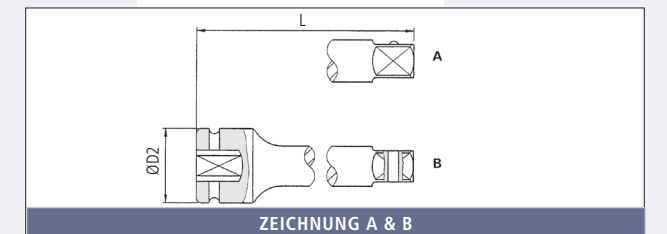

VERLÄNGERUNG WOBBLE

VERLÄNGERUNG WOBBLE

Typ			D2 mm	L mm	Typ
Zoll					
DO6450F050	1/4"	1/4"	13	50	Kugelsicherung
DO6450F075	1/4"	1/4"	13	75	Kugelsicherung
DO6450F100	1/4"	1/4"	13	100	Kugelsicherung
DO6451F050	3/8"	3/8"	19	50	Kugelsicherung
DO6451F075	3/8"	3/8"	19	75	Kugelsicherung
DO6451F100	3/8"	3/8"	19	100	Kugelsicherung
DO6451F200	3/8"	3/8"	19	200	Kugelsicherung
DO6452F075	1/2"	1/2"	25	75	Kugelsicherung
DO6452F125	1/2"	1/2"	25	125	Kugelsicherung
DO6452F150	1/2"	1/2"	25	150	Kugelsicherung
DO6452F200	1/2"	1/2"	25	200	Kugelsicherung

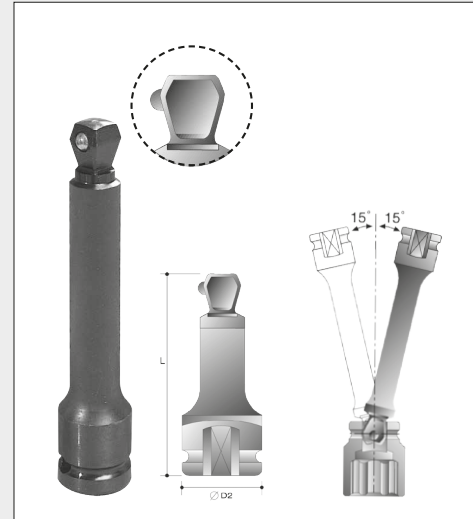

KUGELGELENKE

KUGELGELENKE MIT KUGELSICHERUNG

Typ			Zeichnung	D2 mm	L mm
Zoll					
DO6781F1T	1/4"	1/4"	A	16	43
DO6782F2T	3/8"	3/8"	A	24	50
DO6783F3T	1/2"	1/2"	A	32	60
DO6784F4T	3/4"	3/4"	A	44	90



KUGELGELENKE MIT STIFTLOCH

Typ			Zeichnung	D2 mm	L mm
Zoll					
DO9014-0-000	1/4"	1/4"	B	16	43
DO9038-0-000	3/8"	3/8"	B	24	50
DO9012-0-000	1/2"	1/2"	B	32	60
DO9034-0-000	3/4"	3/4"	B	44	105
DO9100-0-000	1"	1"	B	54	110
DO9112-0-000	1 1/2"	1 1/2"	B	86	182



Ring und Stift werden bei den Kugelgelenken mit Stiftloch nicht mitgeliefert.

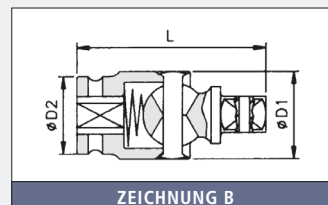
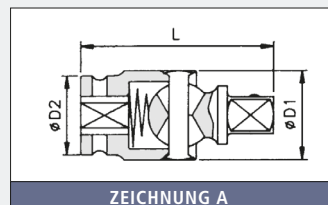

VERBINDUNGSTEIL MIT AUSSENVIERKANT

Typ			Zeichnung	L mm	D mm
Zoll					
DO69306050	1/4"	1/4"	C	50	9
DO69306075	1/4"	1/4"	C	75	9
DO69306100	1/4"	1/4"	C	100	9
DO69306150	1/4"	1/4"	C	150	9
DO69316050	3/8"	1/4"	C	50	13
DO69316075	3/8"	1/4"	C	75	13
DO69316100	3/8"	1/4"	C	100	13
DO69318075	3/8"	7/16"	D	75	13
DO6932E050	1/2"	1/4"	C	50	17
DO69328075	1/2"	7/16"	D	75	17



REDUZIERSTÜCKE / ADAPTER

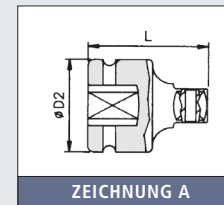

ADAPTER MIT STIFTLOCH



Typ			Zeichnung	D2 mm	L mm
Zoll					
DO8014-0-038	1/4"	3/8"	A	13	26
DO8038-0-014	3/8"	1/4"	A	22	32
DO8038-0-012	3/8"	1/2"	A	22	36
DO8012-0-034	1/2"	3/4"	A	30	48
DO8012-0-038	1/2"	3/8"	A	26	38
DO8034-0-012	3/4"	1/2"	A	40	58
DO8034-0-100	3/4"	1"	A	40	63
DO8100-0-034	1"	3/4"	A	52	80
DO8100-0-112	1"	1 1/2"	A	52	91
DO8112-0-100	1 1/2"	1"	A	84	95
DO8112-0-212	1 1/2"	2 1/2"	A	86	120
DO8134-0-112	1 3/4"	1 1/2"	A	127	153
DO8212-0-112	2 1/2"	1 1/2"	A	127	138

ADAPTER MIT KUGELSICHERUNG



Typ			Zeichnung	D2 mm	L mm
Zoll					
DO64001012	1/4"	3/8"	A	13,6	26
DO64011008	3/8"	1/4"	A	22	32
DO6822F3T	3/8"	1/2"	A	22	36
DO6823F2T	1/2"	3/8"	A	25	38
DO64021024	1/2"	3/4"	A	30	48
DO6815L3T	3/4"	1/2"	A	44	56
DO64051024	1"	3/4"	A	54	75

FEDERRING

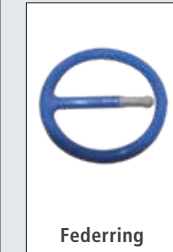

Typ	D2 mm	
DO100325	36,5	3/4"
DO187085	44,5	3/4"
DO187155	53,9	3/4" & 1
DO100085	44,5	1"
DO100215	76,2	1 1/2"
DO100255	85,7	1 1/2"

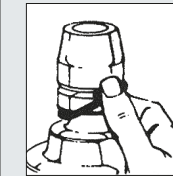

Setzen Sie den Federring über den Antriebsvierkant. Setzen Sie die Kraftstecknuss in Richtung der Haltelöcher. Halten Sie den Mittelstift des Federrings zwischen Daumen und Zeigefinger und stecken ihn durch das Halteloch.

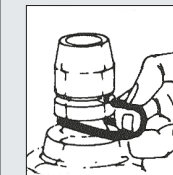

Stecken Sie den Mittelstift ganz durch.

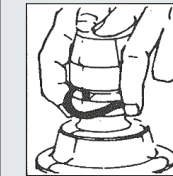

Ziehen Sie den O-Ring des Federrings hoch in die Nut des Kraftsteckschlüssels.

MAGNETISCHE ADAPTER

Die magnetischen Adapter ermöglichen die zeitweise Verwendung größerer Kraftsteckschlüssel bei kleineren Schlagschraubern. Der Magnet sorgt dafür, dass der Adapter den Kraftsteckschlüssel hält. Dieses Set ist ideal für den Werkzeugkasten des reisenden Servicetechnikers, bei Wartung und Reparaturen an zum Beispiel schweren Maschinen.

Typ			Form	D2 mm	L mm
Zoll					
DO69880P12	1/4"	3/8"	A	19	17
DO69880P16	1/4"	1/2"	A	25	22
DO69881P16	3/8"	1/2"	A	25	22
DO69881P20	1/2"	5/8"	A	35	23
DO69882P24	1/2"	3/4"	A	44	30
DO69884P32	3/4"	1"	B	54	35
DO69885P48	1"	1-1/2"	B	86	50
DO69886P80	1-1/2"	2-1/2"	B	127	59
DO69888P01	2-1/2"	3-1/2"	B	176	95

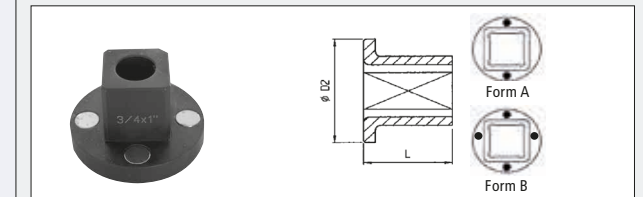

ACTION
VERBINDUNGSTEILE

SCHNELLWECHSELHALTER



SCHNELLWECHSELHALTER 1

Typ	Zeichnung			D2 mm	L mm
Zoll					
DO69110C08	A	1/4"	1/4"	13	35
DO69110C12	A	1/4"	3/8"	13	42
DO69111C12	A	3/8"	3/8"	19	46
DO69111C16	A	3/8"	1/2"	22	60
DO69112C12	A	1/2"	3/8"	25	54
DO69112C16	A	1/2"	1/2"	25	60
DO69114C16	A	3/4"	1/2"	44	70
DO69114C24	A	3/4"	3/4"	44	78
DO69115C24	A	1"	3/4"	54	90
DO69115C32	A	1"	1"	54	100
DO69115C64	A	1"	3/4"	54	300

SCHNELLWECHSELHALTER 2

Typ	Zeichnung			D2 mm	L mm	Bithalter
Zoll						
DO69111A14	B	3/8"	7/16"	22	51	E
DO69112A14	B	1/2"	7/16"	25	54	E

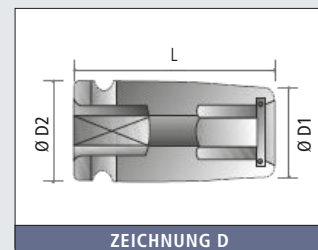
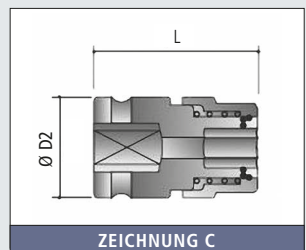
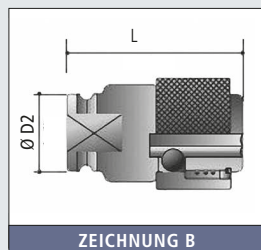
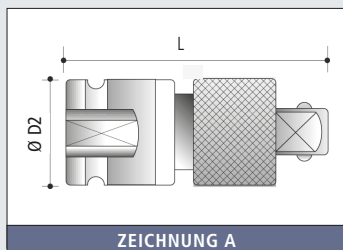

SCHNELLWECHSELHALTER 3

Typ	Zeichnung			D2 mm	L mm	Bit-holder
Zoll						
DO69121B08	C	3/8"	1/4"	19	33	C
DO69122B08	C	1/2"	1/4"	25	41	C

ADAPTER ANTRIEBS-4K AUF BITHALTER (6K) 4

Typ	Zeichnung			D1 mm	D2 mm	L mm	Bithalter
Zoll							
DO69121008	D	3/8"	1/4"	12,5	19	32	C
DO69121010	D	3/8"	5/16"	14	19	37	C
DO69121016	D	3/8"	1/2"	19	19	37	C
DO69122008	D	1/2"	1/4"	12,5	25	40	C
DO69122010	D	1/2"	5/16"	15,5	25	40	C
DO69122016	D	1/2"	1/2"	20	25	40	C

ACTION
VERBINDUNGSTEILE

SCHNELLWECHSELHALTER

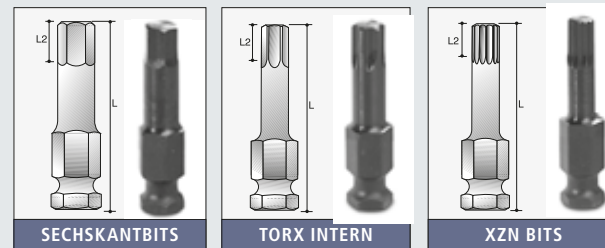

SECHSKANTBITS - 7/16"

Typ		Zeichnung		L2 mm	L mm
Zoll					
DO697RG606	7/16"	A	6	6	60
DO697RG608	7/16"	A	8	8	60
DO697RG610	7/16"	A	10	10	60
DO697RG612	7/16"	A	12	10	60
DO697RG614	7/16"	A	14	10	60
DO697RG617	7/16"	A	17	10	60

XZN BITS - 7/16"

Typ		Zeichnung		L2 mm	L mm
Zoll					
DO698JG110	7/16"	A	M10	9	60

6-KANT-TORX®-INTERN-BITS - 7/16"

Typ		Zeichnung		L2 mm	L mm
Zoll					
DO697LG130	7/16"	A	T30	3,8	60
DO697LG140	7/16"	A	T40	3,8	60
DO697LG145	7/16"	A	T45	4,3	60
DO697LG150	7/16"	A	T50	5	60
DO697LG155	7/16"	A	T55	5,5	60
DO697LG160	7/16"	A	T60	8	60

Auch erhältlich als Set DO691121301, siehe Seite 182



ACTION

SPINDELGEFÜHRTE STECKSCHLÜSSEL

SPINDELGEFÜHRTE KRAFTSTECKSCHLÜSSEL

Kraftsteckschlüssel mit Spindelführung wurden auf Wunsch von Yokota durch ACTION entwickelt, um die Qualität der Schraubverbindung mit Impulsschraubern zu verbessern. Spindelgeführte Steckschlüssel haben ein minimales Spiel zwischen Kraftsteckschlüssel und Antriebsspindel. Dadurch wird das „Wackeln“ reduziert und die Drehmomentverluste werden geringer. Der Einsatz von spindelgeführten Steckschlüsseln bietet nicht nur Vorteile für die Verschraubung, sondern vermindert auch den Geräuschpegel und Verschleiß sowie die Vibration der Maschine für den Anwender.

⚠ VORSICHT

Tragen Sie immer eine Sicherheitsbrille bei der Verwendung von Kraftsteckschlüssel und Halten Sie keinen Kraftsteckschlüssel fest, wenn die Maschine in Betrieb ist.

ACTION SPINDELGEFÜHRTE KRAFTSTECKSCHLÜSSEL: REDUZIERTE VIBRATION!

ACTION spindelgeführte Kraftsteckschlüssel vermeiden das „Wackeln“ auf dem Antriebsvierkant durch Unterstützung eines Stützringes auf der Antriebsspindel.

SPINDELGEFÜHRTE KRAFTSTECKSCHLÜSSEL GARANTIEREN:

- Verbesserung des Drehmoments
- reduzierte Vibration
- reduzierten Geräuschpegel
- reduzierten Verschleiß



ACTION

SPINDELGEFÜHRTE STECKSCHLÜSSEL



□ 3/8" ANTRIEB

6-KANT NORMAL							1
Typ	mm	Zeichnung	D1 mm	D2 mm	L mm	L2 mm	
Metrisch							
DO60910006	6	A	11	19	43	5	
DO60910008	8	A	13	19	43	7	
DO60910009	9	A	15	19	43	7	
DO60910010	10	A	16	19	43	8	
DO60910011	11	A	17,5	19	43	9	
DO60910012	12	B	19	19	43	9	
DO60910013	13	A	20	22	43	9	
DO60910014	14	A	21	22	43	9	
DO60910015	15	B	22	22	43	11	
DO60910016	16	C	24	22	43	11	
DO60910017	17	C	25	22	43	11	
DO60910018	18	C	26	22	43	11	
DO60910019	19	C	27,5	22	43	11	
DO60910021	21	C	30	22	43	13	

6-KANT NORMAL MAGNETISCH							1
Typ	mm	Zeichnung	D1 mm	D2 mm	L mm	L2 mm	
Metrisch							
DO6091A006	6	A	11	19	43	5	
DO6091A007	7	A	12	19	43	5	
DO6091A008	8	A	13	19	43	7	
DO6091A009	9	A	15	19	43	7	
DO6091A010	10	A	16	19	43	8	
DO6091A011	11	A	17,5	19	43	9	
DO6091A012	12	B	18,5	19	43	9	
DO6091A013	13	A	20	22	43	9	
DO6091A014	14	A	21	22	43	9	
DO6091A016	16	C	24	22	43	11	
DO6091A017	17	C	25	22	43	11	
DO6091A018	18	C	26	22	43	11	
DO6091A019	19	C	27	22	43	11	
DO6091A020	20	C	28	22	43	13	
DO6091A021	21	C	30	22	43	13	
DO6091A022	22	C	31	22	50	13	
DO6091A023	23	C	32	22	50	13	
DO6091A024	24	C	34	22	50	13	
DO6091A025	25	C	35	22	50	13	
DO6091A026	26	C	36	22	50	13	
DO6091A027	27	C	38	22	50	13	

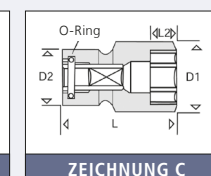
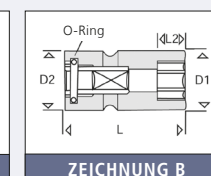
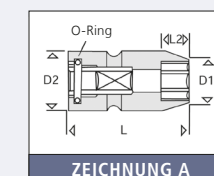

6-KANT LANG							2
Typ	mm	Zeichnung	D1 mm	D2 mm	L mm	L2 mm	
Metrisch							
DO60913006	6	D	10,5	22	100	4	
DO60913008	8	D	12,5	22	100	8	
DO60913010	10	D	15	22	100	8	
DO60913012	12	D	18	22	100	9	
DO60913013	13	D	19	22	100	9	
DO60913014	14	D	20	22	100	9	
DO60913015	15	D	21	22	100	11	
DO60913016	16	D	22,5	22	100	11	
DO60913017	17	D	24	22	100	11	
Imperial							
DO60914006	6	D	10,5	22	150	4	
DO60914008	8	D	12,5	22	150	8	
DO60914010	10	D	15	22	150	8	
DO60914012	12	D	18	22	150	9	
DO60914013	13	D	19	22	150	9	
DO60914014	14	D	20	22	150	9	
DO60914015	15	D	21	22	150	11	
DO60914016	16	D	22,5	22	150	11	
DO60914017	17	D	24	22	150	11	
Imperial							
DO60915006	6	D	10,5	22	200	4	
DO60915008	8	D	12,5	22	200	8	
DO60915010	10	D	15	22	200	8	
DO60915012	12	D	18	22	200	9	
DO60915013	13	D	19	22	200	9	
DO60915014	14	D	20	22	200	9	
DO60915015	15	D	21	22	200	11	
DO60915016	16	D	22,5	22	200	11	
DO60915017	17	D	24	22	200	11	
DO60915019	19	D	27	22	200	11	

6-KANT LANG MAGNETISCH							3
Typ	mm	Zeichnung	D1 mm	D2 mm	L mm	L2 mm	
Metrisch							
DO6091P006	6	D	11	19	100	3	
DO6091P007	7	D	12	19	100	3	
DO6091P008	8	D	13	19	100	4	
DO6091P009	9	D	15	19	100	4	
DO6091P010	10	D	16	19	100	4	
DO6091P011	11	D	17,5	19	100	5	
DO6091P012	12	D	18,5	19	100	5	
DO6091P013	13	D	20	22	100	6	
DO6091P014	14	D	21	22	100	6	
DO6091P015	15	D	22	22	100	7	
DO6091P016	16	D	24	22	100	7	
DO6091P017	17	D	25	22	100	7	
Imperial							
DO6091R008	8	D	13	19	150	4	
DO6091R010	10	D	16	19	150	4	
DO6091R011	11	D	17,5	19	150	5	

SPINDELGEFÜHRTE STECKSCHLÜSSEL

3/8" ANTRIEB

6-KANT LANG MAGNETISCH (FORTSETZUNG) 1

Typ	Zeichnung	D1 mm	D2 mm	L mm	L2 mm	
Metrisch						
DO6091R012	12	D	18,5	19	150	5
DO6091R013	13	D	20	22	150	6
DO6091R014	14	D	21	22	150	6
DO6091R015	15	D	22	22	150	7
DO6091R016	16	D	24	22	150	7
DO6091R017	17	D	25	22	150	7

DO6091T008	8	D	13	19	200	4
DO6091T009	9	D	15	19	200	4
DO6091T010	10	D	16	19	200	4
DO6091T012	12	D	18,5	19	200	5
DO6091T013	13	D	20	22	200	6
DO6091T014	14	D	21	22	200	6
DO6091T015	15	D	22	22	200	7

6-KANT TIEF MAGNETISCH 2

Typ	Zeichnung	D1 mm	D2 mm	L mm	L2 mm	
Metrisch						
DO6091Q010	10	F	16	19	100	5
DO6091Q012	12	F	18,5	19	100	6
DO6091Q013	13	F	20	22	100	6
DO6091Q014	14	F	21	22	100	6
DO6091Q016	16	F	24	22	100	7

TORX® INTERN 3

Typ	Zeichnung	L1 mm	D2 mm	L mm	-	
DO68811009	T9	E	2	22	75	-
DO68811010	T10	E	2,8	22	75	-
DO68811015	T15	E	2,8	22	75	-
DO68811020	T20	E	2,8	22	75	-
DO68811025	T25	E	3	22	75	-
DO68811027	T27	E	3	22	75	-
DO68811030	T30	E	3,8	22	75	-
DO68811040	T40	E	3,8	22	75	-
DO68811045	T45	E	4,3	22	75	-
DO68811047	T47	E	5	22	75	-
DO68811050	T50	E	5	22	75	-
DO68811055	T55	E	5	22	75	-

Torx® ist eine Handelsmarke von Textron.

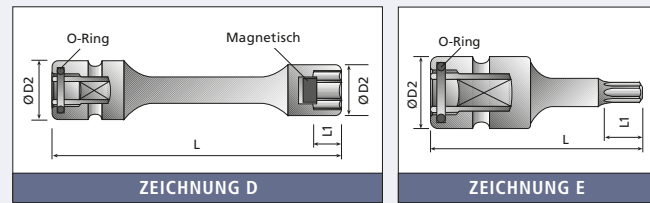

TORX® EXTERN 4

Type	Zeichnung	D1 mm	D2 mm	L mm	L2 mm	
DO66910005	E5	A	8	19	43	4,5
DO66910006	E6	A	9	19	43	5,0
DO66910007	E7	A	9,5	19	43	6,0
DO66910008	E8	A	11	19	43	6,5
DO66910010	E10	A	13	19	43	7,5
DO66910011	E11	A	14	19	43	8,0
DO66910012	E12	A	15,5	19	43	8,5
DO66910014	E14	A	17,5	22	43	10,0
DO66910016	E16	A	18,5	22	43	11,0

Torx® ist eine Handelsmarke von Textron.

AUSSEN-6-KANT (INBUS) 5

Typ	Zeichnung	L1 mm	D2 mm	L mm	-	
Metrisch						
DO68916003	3	E	11	22	75	-
DO68916004	4	E	11	22	75	-
DO68916005	5	E	11	22	75	-
DO68916006	6	E	11	22	75	-
DO68916007	7	E	16	22	75	-
DO68916008	8	E	16	22	75	-
DO68916009	9	E	16	22	75	-
DO68916010	10	E	16	22	75	-
DO68916011	11	E	16	22	75	-
DO68916012	12	E	16	22	75	-
DO68916013	13	E	16	22	75	-
DO68916014	14	E	16	22	75	-
DO68916015	15	E	16	22	75	-
DO68916016	16	E	16	22	75	-

STEBBOLZENSETZER

Typ	Gewinde	D1 mm	D2 mm	L mm
DO66A10062	M6 x 1	12,5	22	50
DO66A10083	M8 x 1,25	15	22	50
DO66A10104	M10 x 1,5	17	22	50

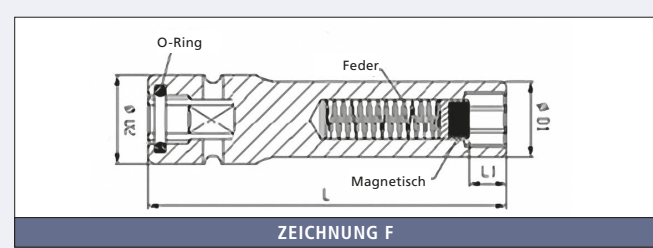

SPINDELGEFÜHRTE STECKSCHLÜSSEL

1/2" ANTRIEB

6-KANT NORMAL 1

Typ	Zeichnung	D1 mm	D2 mm	L mm	L2 mm	
Metrisch						
DO60920012	12	A	20	25	52	12
DO60920013	13	A	21	25	52	12
DO60920014	14	A	22,5	25	52	12
DO60920015	15	A	23,7	30	52	12
DO60920016	16	A	25	30	52	12
DO60920017	17	A	26	30	52	12
DO60920018	18	A	27,5	30	52	12
DO60920019	19	A	28,7	30	52	12
DO60920021	21	B	30	30	52	12
DO60920022	22	C	32	30	52	12
DO60920023	23	C	32	30	52	12
DO60920024	24	C	35	30	52	12
DO60920025	25	C	36	30	57	12
DO60920027	27	C	39	30	57	12
DO60920030	30	C	42	30	62	12
DO60920032	32	C	44	30	62	12

6-KANT LANG 2

Typ	Zeichnung	D1 mm	D2 mm	L mm	L2 mm	
Metrisch						
DO60923010	10	D	17	25	100	12
DO60923012	12	D	19,5	25	100	12
DO60923013	13	D	20,5	25	100	12
DO60923014	14	D	21,5	25	100	12
DO60923015	15	D	22,5	25	100	12
DO60923017	17	D	25	25	100	13
DO60923019	19	D	28	25	100	13

DO60924010	10	D	17	25	150	12
DO60924012	12	D	19,5	25	150	12
DO60924013	13	D	20,5	25	150	12
DO60924014	14	D	21,5	25	150	12
DO60924015	15	D	22,5	25	150	12
DO60924017	17	D	25	25	150	13
DO60924019	19	D	28	25	150	13

DO60925010	10	D	17	25	200	12
DO60925012	12	D	19,5	25	200	12
DO60925013	13	D	20,5	25	200	12
DO60925014	14	D	21,5	25	200	12
DO60925015	15	D	22,5	25	200	12
DO60925017	17	D	25	25	200	13
DO60925019	19	D	28	25	200	13



6-KANT LANG MAGNETISCH 3

Typ	Zeichnung	D1 mm	D2 mm	L mm	L2 mm	
Metrisch						
DO6092P010	10	D	17,5	25	100	4
DO6092P011	11	D	18,5	25	100	5
DO6092P012	12	D	20	25	100	5
DO6092P013	13	D	21	25	100	6
DO6092P014	14	D	22,5	25	100	6
DO6092P015	15	D	23,5	30	100	7
DO6092P016	16	D	25	30	100	7
DO6092P017	17	D	26	30	100	7
DO6092P018	18	D	27,5	30	100	8
DO6092P019	19	D	28,5	30	100	8

DO6092R010	10	D	17,5	25	150	12
DO6092R011	11	D	18,5	25	150	12
DO6092R012	12	D	20	25	150	12
DO6092R013	13	D	21	25	150	12
DO6092R014	14	D	22,5	25	150	12
DO6092R015	15	D	23,5	30	150	12
DO6092R016	16	D	25	30	150	13
DO6092R017	17	D	26	30	150	13
DO6092R018	18	D	27,5	30	150	13
DO6092R019	19	D	28,5	30	150	13

DO6092T010	10	D	17,5	25	200	12
DO6092T011	11	D	18,5	25	200	12
DO6092T012	12	D	20	25	200	12
DO6092T013	13	D	21	25	200	12
DO6092T014	14	D	22,5	25	200	12
DO6092T015	15	D	23,5	30	200	12
DO6092T016	16	D	25	30	200	13
DO6092T017	17	D	26	30	200	13
DO6092T018	18	D	27,5	30	200	13
DO6092T019	19	D	28,5	30	200	13

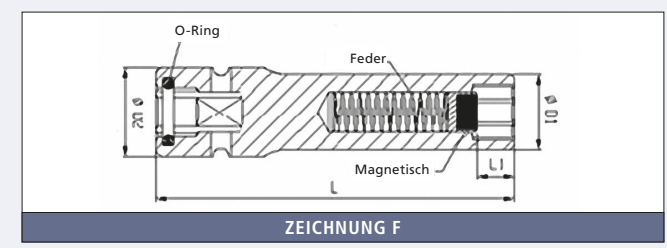
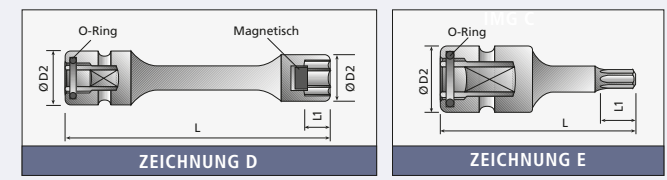
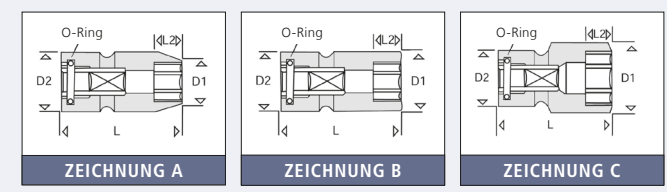

SPINDELGEFÜHRTE STECKSCHLÜSSEL

1/2" ANTRIEB



6-KANT NORMAL MAGNETISCH 1						
Typ	Zeichnung	D1 mm	D2 mm	L mm	L2 mm	
Metrisch						
DO6092A006	6	A	13	25	52	5
DO6092A007	7	A	14	25	52	5
DO6092A008	8	A	15	25	52	7
DO6092A009	9	A	16	25	52	7
DO6092A010	10	A	17,5	25	52	8
DO6092A011	11	A	18,5	25	52	9
DO6092A012	12	A	20	25	52	12
DO6092A013	13	A	21	25	52	12
DO6092A014	14	A	22,5	25	52	12
DO6092A015	15	A	23,5	30	52	12
DO6092A016	16	A	25	30	52	12
DO6092A017	17	A	26	30	52	12
DO6092A018	18	A	27,5	30	52	12
DO6092A019	19	A	28,5	30	52	12
DO6092A020	20	B	30	30	52	12
DO6092A021	21	C	31	30	52	12
DO6092A022	22	C	32	30	52	12
DO6092A023	23	C	34	30	52	12
DO6092A024	24	C	35	30	52	12
DO6092A025	25	C	36	30	57	12
DO6092A026	26	C	38	30	57	12
DO6092A027	27	C	38,5	30	57	12



6-KANT TIEF MAGNETISCH 2						
Typ	Zeichnung	D1 mm	D2 mm	L mm	L1 mm	
Metrisch						
DO6092Q010	10	F	17,5	25	100	5
DO6092Q013	13	F	21	25	100	6
DO6092Q016	16	F	25	30	100	7
DO6092Q017	17	F	26	30	100	7
DO6092Q019	19	F	28,5	30	100	8

TORX® EXTERN 3						
Typ	Zeichnung	D1 mm	D2 mm	L mm	L2 mm	
DO66920010	E10	A	14	25	52	7,5
DO66920011	E11	A	15	25	52	8
DO66920012	E12	A	16	25	52	8,5
DO66920014	E14	A	18	25	52	10
DO66920016	E16	A	20	25	52	11
DO66920018	E18	A	22	25	52	12,5
DO66920020	E20	A	25	30	52	14
DO66920022	E22	A	27	30	52	15
DO66920024	E24	A	29	30	52	16,5

Torx® ist eine Handelsmarke von Textron.



TORX® INTERN 4						
Typ	Zeichnung	L1 mm	D2 mm	L mm	-	
DO68821020	T20	E	2,8	25	75	-
DO68821025	T25	E	3	25	75	-
DO68821027	T27	E	3	25	75	-
DO68821030	T30	E	3,8	25	75	-
DO68821040	T40	E	3,8	25	75	-
DO68821045	T45	E	4,3	25	75	-
DO68821047	T47	E	5	25	75	-
DO68821050	T50	E	5	25	75	-
DO68821055	T55	E	5,5	25	75	-
DO68821060	T60	E	8	25	75	-
DO68821070	T70	F	9,4	25	75	-
DO68821080	T80	E	10,5	25	75	-
DO68821090	T90	E	11,8	25	75	-
DO68821100	T100	E	13,1	25	75	-

Torx® ist eine Handelsmarke von Textron.

AUSSEN-6-KANT (INBUS) 5						
Typ	Zeichnung	L1 mm	D2 mm	L mm	-	
Metrisch						
DO68925003	3	E	11	25	75	-
DO68925004	4	E	11	25	75	-
DO68925005	5	E	15	25	75	-
DO68925006	6	E	15	25	75	-
DO68925007	7	E	20	25	75	-
DO68925008	8	E	25	25	75	-
DO68925009	9	E	25	25	75	-
DO68925010	10	F	25	25	75	-
DO68925011	11	E	25	25	75	-
DO68925012	12	E	25	25	75	-
DO68925013	13	E	25	25	75	-
DO68925014	14	E	25	25	75	-
DO68925015	15	E	25	25	75	-
DO68925016	16	E	25	25	75	-
DO68925017	17	E	25	25	75	-
DO68925018	18	E	25	25	75	-
DO68925019	19	E	25	25	75	-

STEBBOLZENSETZER				
Typ	Gewinde	D1 mm	D2 mm	L mm
DO66A21062	M6 x 1	13	25	75
DO66A21104	M10 x 1,5	17	25	75
DO66A21125	M12 x 1,75	19	25	75
DO66A21146	M14 x 2	22	25	75
DO66A21166	M16 x 2	27	30	75



SPINDELGEFÜHRTE STECKSCHLÜSSEL

3/4" ANTRIEB

6-KANT NORMAL 1						
Typ	Zeichnung	D1 mm	D2 mm	L mm	L2 mm	
Metrisch						
DO60940017	17	A	31	44	65	12
DO60940018	18	A	32	44	65	12
DO60940019	19	A	33	44	65	14
DO60940021	21	A	35	44	65	16
DO60940022	22	A	37	44	65	16
DO60940023	23	A	38	44	65	16
DO60940024	24	A	39	44	65	16
DO60940026	26	A	41	44	65	16
DO60940027	27	A	43	44	65	16
DO60940028	28	B	44	44	68	20
DO60940029	29	C	45	44	68	20
DO60940030	30	C	47	44	68	20
DO60940032	32	C	49	44	70	20
DO60940033	33	C	51	44	70	20
DO60940034	34	C	52	44	70	20
DO60940035	35	C	53	44	70	20
DO60940036	36	C	54	44	70	20
DO60940038	38	C	57	44	72	22
DO60940041	41	C	60	44	72	22
DO60940046	46	C	67	54	77	23
DO60940050	50	C	71	54	77	23

6-KANT MAGNETISCH 2						
Typ	Zeichnung	D1 mm	D2 mm	L mm	L2 mm	
Metrisch						
DO6094A013	13	A	24,5	44	65	12
DO6094A014	14	A	25,5	44	65	12
DO6094A015	15	A	27	44	65	12
DO6094A016	16	A	28	44	65	12
DO6094A017	17	A	30	44	65	12
DO6094A018	18	A	31	44	65	12
DO6094A019	19	A	32	44	65	14
DO6094A020	20	A	34	44	68	14
DO6094A021	21	A	35	44	68	16
DO6094A022	22	A	37	44	68	16
DO6094A023	23	A	38	44	68	16
DO6094A024	24	A	39	44	68	16
DO6094A025	25	A	41	44	69	16
DO6094A026	26	A	42	44	69	16
DO6094A027	27	A	43	44	69	16

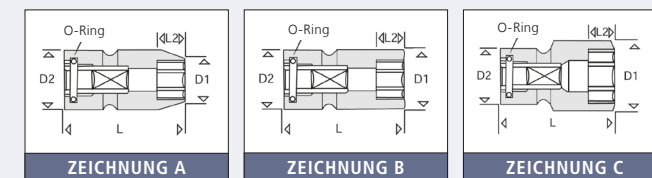

AUSSEN-6-KANT (INBUS) 3						
Typ	Zeichnung	D2 mm	L mm	L2 mm	-	
Metrisch						
DO68945010	10	E	44	100	20	-
DO68945012	12	E	44	100	20	-
DO68945014	14	E	44	100	20	-
DO68945016	16	E	44	100	20	-
DO68945017	17	E	44	100	20	-
DO68945019	19	E	44	100	20	-
DO68945022	22	E	44	100	20	-
DO68945024	24	E	44	100	20	-
DO68945027	27	E	44	100	20	-
DO68945030	30	E	44	100	20	-
DO68945032	32	E	44	100	20	-
DO68945033	33	E	44	100	20	-
DO68945036	36	E	44	100	20	-
DO68945038	38	E	44	100	20	-

Für Zeichnung s.a. S. 178.

TORX® EXTERN 4						
Typ	Zeichnung	D1 mm	D2 mm	L mm	L2 mm	
DO66940018	E18	A	26	44	65	12,5
DO66940020	E20	A	28	44	65	14
DO66940022	E22	A	31	44	65	15
DO66940024	E24	A	33	44	65	16,5

Torx® ist eine Handelsmarke von Textron.

VERLÄNGERUNGEN			
Typ	Zeichnung	L mm	D1 mm
DO64614075	3/8"	75	22
DO64614125	3/8"	125	22
DO64614250	3/8"	250	22
DO64624075	1/2"	75	25
DO64624125	1/2"	125	25
DO64624175	1/2"	175	25
DO64624250	1/2"	250	25
DO64644175	3/4"	175	44
DO64644250	3/4"	250	44
DO64644330	3/4"	330	44

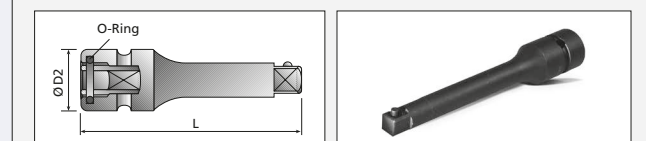

ACTION

SPINDELGEFÜHRTE STECKSCHLÜSSEL



VERBINDUNGSTEILE

SPINDELGEFÜHRTE SCHNELLWECHSELHALTER 1					
Typ			D2 mm	L mm	-
Metrisch					
D069151112	3/8"	3/8"	19	75	-
D069151212	3/8"	3/8"	19	100	-
D069151116	3/8"	1/2"	20	80	-
D069152112	1/2"	3/8"	25	75	-
D069152216	1/2"	1/2"	25	100	-
D069154116	3/4"	1/2"	44	90	-
D069154324	3/4"	3/4"	44	125	-

SPINDELGEFÜHRTE BITHALTER 2					
Typ			D2 mm	L mm	-
Metrisch					
D069111E08	3/8"	1/4"	52	22	-
D069111E14*	3/8"	7/16"	62	22	-
D069112E08	1/2"	1/4"	60	25	-
D069112E14*	1/2"	7/16"	70	25	-
D069114E14*	3/4"	7/16"	80	44	-

* 7/16" Bits s.a. S. 174.

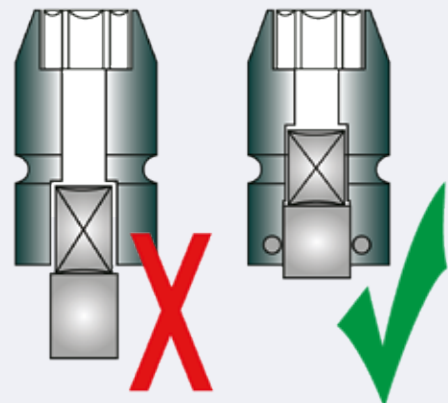

ACTION

SETS KRAFTSTECKSCHLÜSSEL

SET STECKSCHLÜSSEL DO605121301 3/8"



13 Kraftsteckschlüssel, 6K, tief 7-8-9-10-11-12-13-14-15-16-17-18-19 mm

SET STECKSCHLÜSSEL DO611101301 3/8"



13 Kraftsteckschlüssel, 6K, dünnwandig 7-8-9-10-11-12-13-14-15-16-17-18-19 mm

SET STECKSCHLÜSSEL DO0012-0-0005 1/2"



10 Kraftsteckschlüssel, 6K, normale Ausführung 9-10-11-13-14-17-19-22-24-27 mm

SET AUSSENSECHKANT STECKSCHLÜSSEL DO69521093 1/2"



9 Inbuskraftsteckschlüssel 4-5-6-8-10-12-14-17-19 mm

TORX INTERN 6K-INBUS-BITS DO691121301 1/2"



1 Stück 1/2" Schnellwechsler 7/16" Sechskant
6 Stück 7/16" 6K intern Torx Bits: T30-T40-T45-T50-T55-T60
6 Stück 7/16" 6-Kant-inbus-Bits: 6-8-10-12-14-17 mm

SET STECKSCHLÜSSEL DO605222601 1/2"



26 Kraftsteckschlüssel, 6K, tief 10-11-12-13-14-15-16-17-18-19-20-21-22-23-2-25-26-27-28-29-30-32-33-34-35-36 mm

SET STECKSCHLÜSSEL DO605202602 1/2"



26 Kraftsteckschlüssel, 6K 10-11-12-13-14-15-16-17-18-19-20-21-22-23-24-25-26-27-28-29-30-32-33-34-35-36 mm

SET STECKSCHLÜSSEL DO69523108 1/2"



10 Kraftsteckschlüssel, 6K, tief 10-11-13-14-17-19-21-22-24-27 mm

SET STECKSCHLÜSSEL DO652260701 1/2"



7 Kraftsteckschlüssel, XZN Bit M5-M6-M8-M10-M12-M14-M16

Sehr gut geeignet für Werkstatt und Servicezentren von Pkw aus dem Volkswagen-Konzern.

KRAFTSTECKSCHLÜSSEL

SET KRAFTSTECKSCHLÜSSEL
 DO61120310

 1/2"

3 Kraftsteckschlüssel mit Kunststoffanschlag und -hülse
blau 17 mm - gelb 19 mm - rot 21 mm

KRAFTSTECKSCHLÜSSEL SIND AUCH EINZELN LIEFERBAR s.S. 152

SET KRAFTSTECKSCHLÜSSEL
 DO611260501

 1/2"

5 Kraftsteckschlüssel mit Kunststoffanschlag und -hülse
weiß 15 mm - blau 17 mm - gelb 19 mm - rot 21 mm - grün 22 mm

KRAFTSTECKSCHLÜSSEL SIND AUCH EINZELN LIEFERBAR s.S. 152

SET KRAFTSTECKSCHLÜSSEL FÜR RADMUTTERSCHLOSS
 DO0012-0-286

1/2"



7 Kraftsteckschlüssel,
normale Ausführung
17 - 18,5 - 20 - 21,5 - 23 - 24,5 - 26 mm

VERWENDUNG

Die Verwendung der Radmuttereschlossentferner ist nur dann erforderlich, wenn der PKW-Fahrer zum Reifendienst geht und den Originalschlüssel vergessen hat. Um doch das Schloss entfernen zu können, werden diese Nüsse verwendet. Beim Aufstecken des Radmuttereschlossentferners beachte man, dass dieser mindestens 3 Gewindegänge tief im Schloss steckt, damit er genug fassen kann. Wenn der (konische) Steckschlüssel bereits nach einem Gewindegang greift, muss ein größerer Steckschlüssel gewählt werden. Wenn die Nuss mit richtiger Größe so verwendet wird, können bis zu 4 Radschlösser entfernt werden.

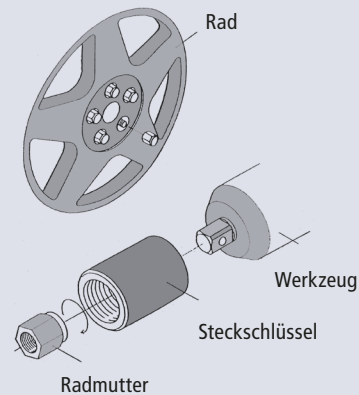
SET MAGNETISCHE KRAFTNÜSSE MIT HÜLSEN
 DO698800401

4-teiliges Set magnetische, reduzierende
Verbindungsteile für Kraftsteckschlüssel
1/4" weiblich x 3/8" männlich
3/8" weiblich x 1/2" männlich
1/2" weiblich x 3/4" männlich
3/4" weiblich x 1" männlich

Die reduzierende Hülse ermöglicht die Verwendung größerer Kraftsteckschlüssel auf kleinerem Schlagschrauber. Der Magnet sorgt dafür, dass der Adapter den Kraftsteckschlüssel hält. Dieses Set ist ideal für die Toolbox des reisenden Servicetechnikers, bei Wartung und Reparaturen an zum Beispiel schweren Baumaschinen.

SETS STECKSCHLÜSSEL
TORSIONSKRAFTSTECKSCHLÜSSEL & SPECIALS
SET STECKSCHLÜSSEL
 DO605401001

 3/4"

10 Kraftsteckschlüssel,
6K, normale Ausführung
21 - 22 - 24 - 27 - 30 - 32 - 33 - 36 - 41 - 46 mm

SET STECKSCHLÜSSEL
 DO605421001

 3/4"

10 Kraftsteckschlüssel,
6K, tief
21 - 22 - 24 - 27 - 30 - 32 - 33 - 36 - 41 - 46 mm

SET STECKSCHLÜSSEL
 DO0100-1-007

 1"

7 Kraftsteckschlüssel,
6K, tief
24 - 27 - 30 - 32 - 33 - 36 - 41 mm

TORSIONSKRAFTSTECKSCHLÜSSEL

1/2"
+ 1"

1/2"	A/F mm	Nm	Länge	Farbe
DO68122D17	17	75	220	Grün
DO68122L17	17	110	220	Rot
DO68122G19	19	90	220	Gelb
DO68122L19	19	110	220	Blau
DO68122M19	19	135	220	Grau
DO68122E21	21	80	220	Schwarz
DO68122L21	21	110	220	Braun

1"	A/F mm	Nm	Länge
DO68552U23	23	250	305
DO68552W24	24	350	305
DO68552W27	27	350	305
DO68552Z27	27	450	305
DO68552Y29	29	400	305
DO68552B30	30	550	305
DO68552C30	30	600	305
DO68552A32	32	500	305
DO68552C32	32	600	305
DO68552F32	32	700	305
DO68552A33	33	500	305
DO68552C33	33	600	305
DO68552C36	36	600	305

RADMUTTERNUSS FÜR RADMUTTERN VON MERCEDES (1/2" X 17 mm)
 DO6112P017

SPECIAL



Inklusive drehbarer Kunststoffhülse und -anschlag für den Schutz von Leichtmetallrädern.

Diese Sondernuss ist entwickelt für Mercedes:
C-Klasse/GLK (W204), E-Klasse (W211, W212, W207), SLK (W172), M-Klasse (W164, W166), CL-Klasse (W216), S-Klasse (W221, W222) und Maybach.